

ETEK[®]
E TEK ELECTRIC

SOLAR DOCTOR PV

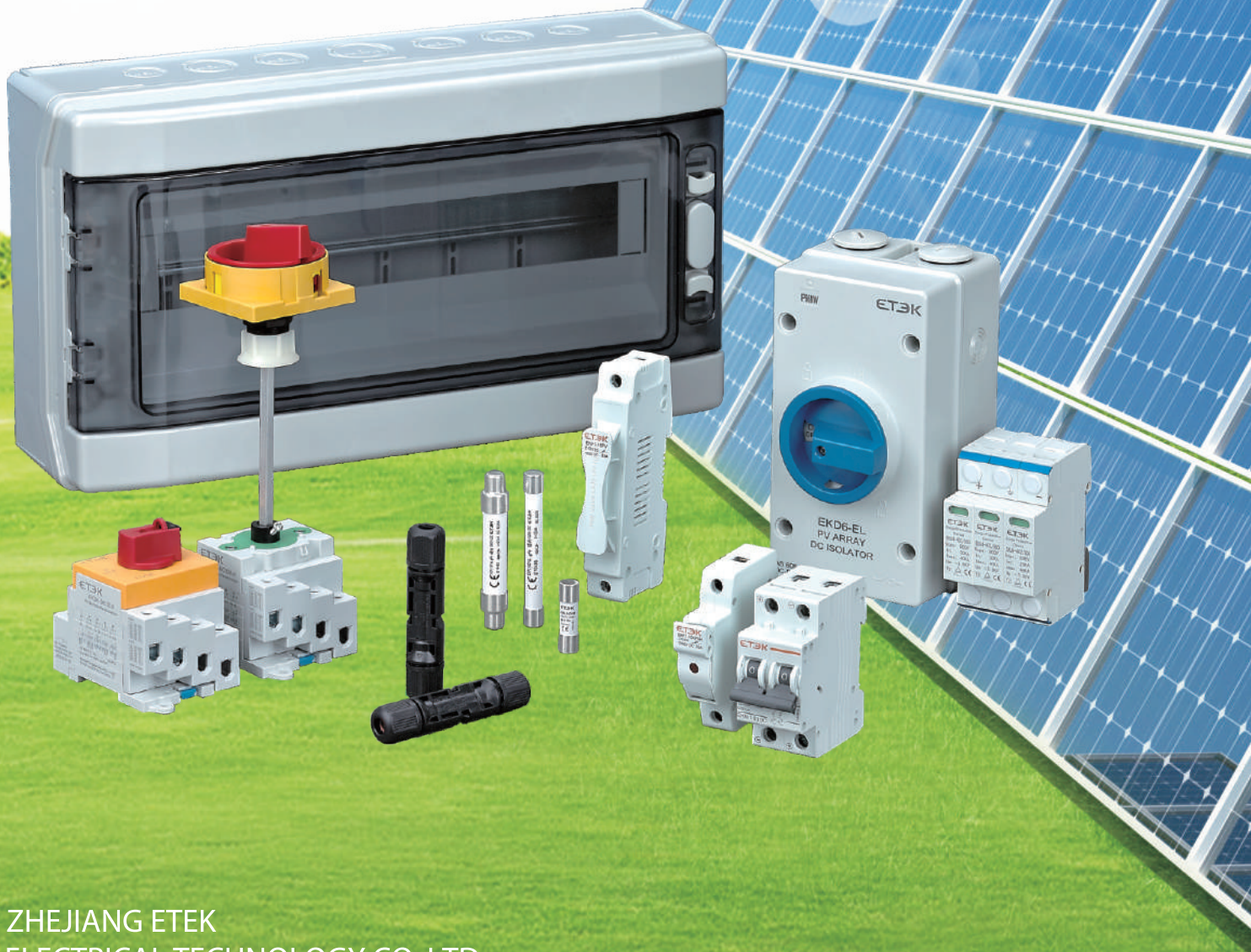

ZHEJIANG ETEK
ELECTRICAL TECHNOLOGY CO.,LTD.

COMPANY

>>> INTRODUCTION



Zhejiang ETEK Electrical Technology Co.,Ltd. was founded on January of 2011, which has more than 200 employees now. It is a professional manufacturing company engaging in R & D, production and sale of high and low voltage electrical products, such as Terminal distribution electrical appliances, Industrial distribution electrical appliances, Industrial control electrical appliances, DC systems distribution appliances, etc. It possesses three major manufacturing departments and one import & export trading company. The three manufacturing departments are Terminal distribution electrical appliances manufacturing department, Industrial distribution electrical appliances manufacturing department and Industrial control electrical appliances manufacturing department.

The series of products manufactured by the company are mainly sold to international market. All the products produced are in strictly accordance with international IEC/EN standards and China's GB standards. Most of these product have gained TUV and Intertek issued CCC,CE,TUV,SEMKO,EAC,SAA, INMETRO,ISO9001-2008 certificates and CB test reports. The products are sold to more than 50 countries and regions throughout the world, such as UK, France, Australia, Russia, Ukraine, Turkey, Brazil and so on. The quality of the products has been widely praised by the majority of users.

RoHS

EAC



CB



CE

WORKSHOPS



MAIN PRODUCTS CLASSIFICATION CHART

Manufacturing department of ETEK Electric	Terminal Power Distribution	MCB	
		RCCB & RCBO	
		Isolation Switch	
		Accessories of Breakers	
		Modular Contactor	
		Modular Indicator & Socket	
		Other Modular Products	
	Industrial Power Distribution	MCCB	
		ACB	
		MPCB	
		ATS	
		Isolator	
	Industrial Control	Contactor	
		Thermal Relay	
		Electromagnetic Starter	
		Push Button Switch	
		LED Indicator & Voltage Meter	

LOW-VOLTAGE ELECTRICAL TESTING CENTER

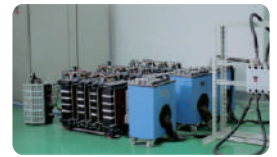

Test Capabilities List

I. Electromagnetic compatibility laboratory

1. Lightning surge immunity test
2. Pulse immunity test of electric fast transient group
3. Electrostatic Discharge immunity test
4. Power frequency magnetic field resistance test
5. Verify the performance
6. Residual current tripping test
7. 2-stage power frequency withstand voltage test
8. Impulse withstand voltage test, leakage current test of RCBO under the condition of surge current generated by impulse voltage

II. Mechanical life laboratory

1. Mechanical life test of Mini Circuit Breaker
2. Mechanical life test of Moulded Case Circuit Breaker
3. Mechanical life test of AC Contactor
4. Small reclosing electrical life test of Electrical Meter External Circuit Breaker

III. High current characteristic laboratory

1. Temperature rise test of Circuit Breaker
2. Characteristics test of Circuit Breaker
3. Reliability test of Intelligent Circuit Breaker Test of Circuit Breaker
4. Product packaging simulation transport vibration

IV. Material property laboratory

1. Thermal bimetallic deflection measurement test
2. Automatic High Voltage continuous film test of enamelled Wire
3. Thermal softening breakdown test of enamelled wire
4. Enamelled wire stripping test
5. Simply supported beam impact test
6. Loop resistance test
7. Intelligent low resistance test

V. Insulating material laboratory

1. Thermal and Ignition Resistance test of Insulation Materials
2. Horizontal vertical combustion
3. Insulating materials-determination of the relative leakage mark index
4. Salt spray corrosion resistance test
5. 5-stage power frequency voltage resistance test

VI. Environmental test chamber

1. High and low temperature hygrothermal test
2. Circuit board aging test
3. Constant temperature test
4. Action characteristics test of AC Contacto
5. Measuring instruments

VII. Comprehensive characteristic laboratory

1. Temperature rise, reliability test of circuit breaker
2. Small reclosing characteristic test
3. Js7 delay characteristics testing
4. Overloading characteristics test of circuit breaker
5. Temperature rise test of CAC Contactor

International Team



Main Exhibition

HANNOVER MESSE	Hannover
MEE	Dubai
FIEE	Sao Paulo
CANTON FAIR	Guangzhou



EKM1-63DC 6KA/10KA DC MCB	01
EKU5-T2-40PV SPD TYPE T2	03
FUSE BASE FOR PV SYSTEM	05
EKD6-DB32	08
EKD6-DC32R	12
EKD6-PM32	14
EKD6-PM32R	16
EKD6-EL32R	18
EKDBPV	21
EKDB3 PC/ABS	28
EKDB4	32
EKDB5	33
PG	37
M	38
PV-LTM4(1000V)/PV-LTM4-1(1000V)	39

EKM1-63DC 6KA/10KA DC MCB

ETЭК

Mini Circuit Breaker

Standard_ IEC60947-2



Technical Data

Electrical Features	Rated current I_n	1,2,3,4,5,6,8,10,13,16,20,25,32,40,50,63A
	Poles	1P, 2P, 4P
	Rated voltage U_e	1P(250V), 2P(500V), 4P(1000V)
	Rated breaking capacity	6,000/10,000A
	Rated impulse withstand voltage(1.5/50) U_{imp}	4,000V
	Dielectric test voltage at ind. Freq. for 1 min	2kV
	Pollution degree	2
	Thermo-magnetic release characteristic	C (7~10) I_n
Mechanical Features	Electrical life	4,000 Cycles
	Mechanical life	10,000 Cycles
	Contact position indicator	Yes
	Protection degree	IP20
	Reference temperature for setting of thermal element	30°C
	Ambient temperature (with daily average $\leq 35^\circ\text{C}$)	-5°C~+40°C
	Storage temperature	-25°C~+70°C
Installation	Terminal connection type	Cable/Pin-type busbar/U-type busbar
	Terminal size top/bottom for cable	25mm ² 18-3AWG
	Terminal size top/bottom for busbar	25mm ² 18-3AWG
	Tightening torque	2.5Nm 22In-lbs
	Mounting	On DIN rail EN60715(35mm) by means of fast clip device
	Connection	According to the wiring diagram
Combination with accessories	Auxiliary contact	EKM1-OF
	Alarm contact	EKM1-FB
	Shunt release	EKM1-MX
	Over/Under voltage release	EKM1-MV+MN

EKM1-63DC 6KA/10KA DC MCB



Mini Circuit Breaker

Standard_ IEC60947-2

MCB Characteristics

Characteristics

Curves

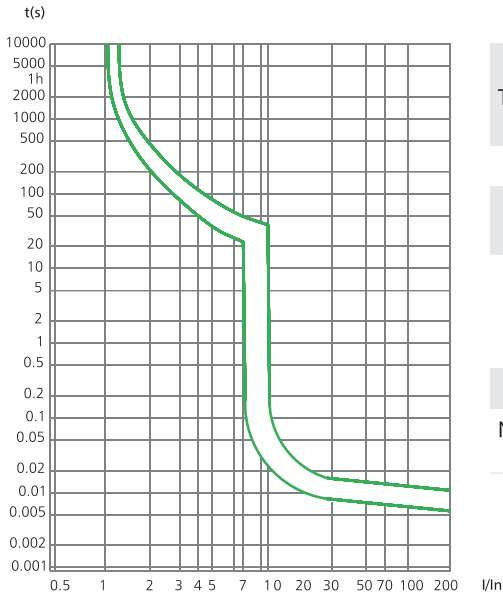

Test	Test current	Initial state	Time limit for tripping or not tripping	Expected result	Remarks
a	1.05I _n	Cold state a	t ≤ 1h	Not tripping	
b	1.30I _n	Right after test number a	t < 1h	Tripping	The current is rising within 5s
c	7I _n	Cold state a	0.2s < t < 15s (I _n ≤ 32A) 0.2s < t ≤ 30s (I _n > 32A)	Tripping	
d	10I _n	Cold state a	t < 0.1s	Tripping	

Note: The terminology "Cold state" means that the test is performed at the base calibration temperature with no load prior to the test.

Circuit Diagram

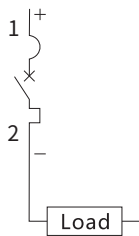

1P

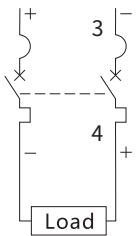

2P

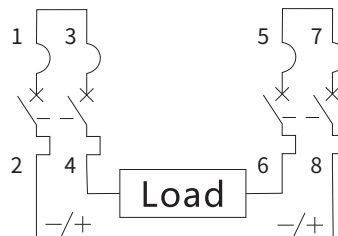

4P

Overall and Installation Dimension(mm)

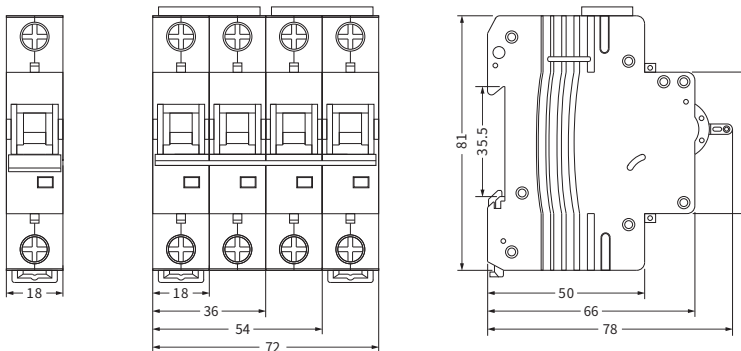

Product Selection Guide

EK U5-T2-40 PV-2M-600 S

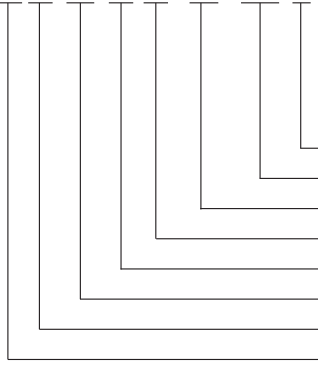

- With Remote Signaling
- Uc: 600: DC600V, 1000: DC1000V, 1500: DC1500V
- No. of Module: 2:2Module, 3:3Module
- Solar PV System
- I.max: 40kA
- Classification T2
- SPD serie No.5
- Company Code



EKU5-T2-40PV
2P(600VDC)



EKU5-T2-40PV
2P(1000VDC)



EKU5-T2-40PV
3P(1000VDC)



EKU5-T2-40PV
3P(1500VDC)

Basic circuit diagram

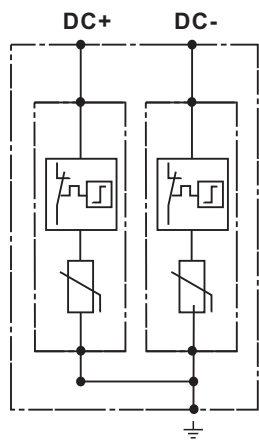

2P

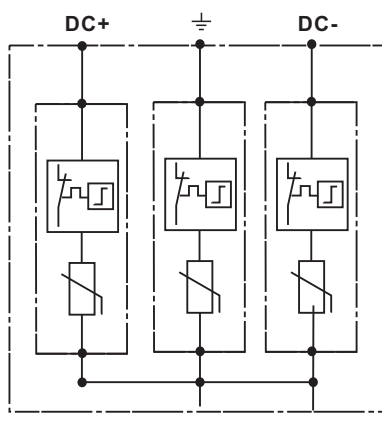

3P

SPD Type Reference List

No. of Poles	Max. Continuous Operating DC Voltage		
	600VDC	1000VDC	1500VDC
2Module	EKU5-T2-40PV-2M600	EKU5-T2-40PV-2M1000	-
3Module	-	EKU5-T2-40PV-3M1000	EKU5-T2-40PV-3M1500
With Remote Signaling			
2Module	EKU5-T2-40PV-2M600S	EKU5-T2-40PV-2M1000S	-
3Module	-	EKU5-T2-40PV-3M1000S	EKU5-T2-40PV-3M1500S

Technical Data

SPD classification according to IEC/EN61643-31		T2	T2	T2
Max. continuous operating a.c.voltage	Uc _{pv}	600VDC	1000VDC	1500VDC
Norminal discharge current (8/20μs)	I _n	20kA	20kA	20kA
Maximum discharge current (8/20μs)	I _{max}	40kA	40kA	40kA
Voltage protection level DC+/DV-to PE	U _p	2Mods	≤2.6kV	≤4.0kV
		3Mods	-	≤4.0kV
Response time	t _A	≤25ns	≤25ns	≤25ns
Operating temperature range	T _u	-40°C~80°C		
Operating State/Fault Indication		Green/Red		
Cross-section area (Min.)		4mm ²		
Cross-section area (Max.)		35mm ²		
For mounting on		35mm Din rail		
Enclosure material		Thermal Plastic UL94-V0		
Degree of Protection		IP20		
No. of Moudles		2P(2Mods),3P(3Mods)		

Overall and Installation Dimension(mm)

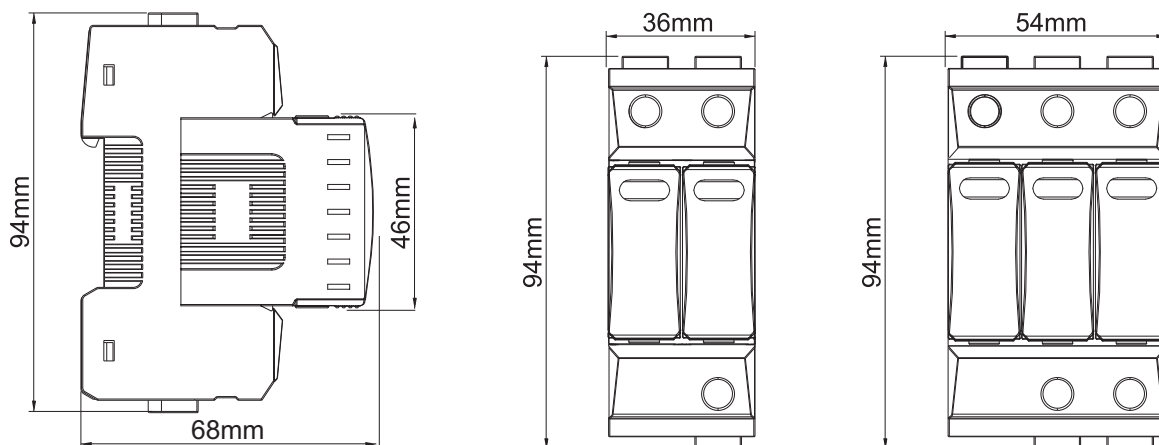

Technical Data



Model						
	EKF1-10PV-10 EKF1-10XPV-10		EKF1-10PVH-10 EKF1-10XPVH-10		EKF1-15PV-10L	EKF1-15PV-14L
Rated Voltage	1000VDC				1500VDC	
Rated Current	32A				32A	50A
Size of Fuse Link	10x38mm				10x85mm	14x85mm
Class of Operation	gPV				gPV	
Mechanical Life	500				500	
Product Width	18mm				22mm	
Tightening Torque	2.5Nm 14In-lbs				2.5Nm 14In-lbs	
Terminal size for Cable	6mm ² 8-18AWG				10mm ² 6-18AWG	
Ambient temperature (with daily average ≤ 35°C)	-5°C ~ +40°C					
Storage Temperature	-25°C ~ +70°C					
Standard:	IEC60269-6					
Mounting	On DIN rail EN60715(35mm) by means of fast clip device					

Product Selection Guide

EKF1-10(X)PV-10	
EK	Company Code
F	Fuse Base
1	Design No.
10	DC Voltage Grade (10: 1000VDC, 15: 1500VDC)
X	Blank: Without Lamp, X : With Lamp
PV	For Solar DC system, PV: General type, PVH: High enclosure type (for EKF1-10PVH-10 new type only)
10	Fitting to Size of Fuse link (10: for 10x38mm 1000V, 10L: for 10x85mm 1500V, 14L: for 14x85mm 1500V)

Reference No.	DC Voltage Grade	Size of Fuse Link	Current Rating for Fuse Link
EKF1-10(X)PV-10	1000VDC	10x38mm	1,2,3,4,5,6,8,10,12,15,16,20,25,30,32A
EKF1-10(X)PVH-10	1000VDC	10x38mm	1,2,3,4,5,6,8,10,12,15,16,20,25,30,32A
EKF1-15PV-10L	1500VDC	10x85mm	2,3,4,5,6,8,10,12,15,16,20,25,30,32A
EKF1-15PV-14L	1500VDC	14x85mm	8,10,12,15,16,20,25,30,32,35,40,45,50A

Technical Data

Model			
	EKFL10D10	EKFL15D10L	EKFL15D14L
Size	10x38mm	10x85mm	14x85mm
Rated Voltage	1000VDC	1500VDC	1500VDC
Rated Current	1-32A	2-32A	8-50A
Class of Operation	gPV	gPV	gPV
Breaking capacity	20KA	20KA	20KA
Standard:	IEC60269		

Product Selection Guide

EKFL-10D10L16
EK Company Code
FL Fuse Link
10 DC Voltage Grade (10:1000VDC,15:1500VDC)
D For Solar DC system
10L Size of Fuse link (10: 10x38mm 1000V, 10L: 10x85mm 1500V, 14L: 14x85mm 1500V)
16 Current Rating (01,02...40,50A)

Current Rating	Reference No. for Fuse Link		
	Voltage Grade and Size of Fuse Link		
	EKFL10D10	EKFL15D10L	EKFL15D14L
	1000VDC	1500VDC	1500VDC
	10x38mm	10x85mm	14x85mm
1A	EKFL10D1001		
2A	EKFL10D1002	EKFL15D10L02	
3A	EKFL10D1003	EKFL15D10L03	
4A	EKFL10D1004	EKFL15D10L04	
5A	EKFL10D1005	EKFL15D10L05	
6A	EKFL10D1006	EKFL15D10L06	
8A	EKFL10D1008	EKFL15D10L08	EKFL15D14L08
10A	EKFL10D1010	EKFL15D10L10	EKFL15D14L10
12A	EKFL10D1012	EKFL15D10L12	EKFL15D14L12
15A	EKFL10D1015	EKFL15D10L15	EKFL15D14L15
16A	EKFL10D1016	EKFL15D10L16	EKFL15D14L16
20A	EKFL10D1020	EKFL15D10L20	EKFL15D14L20
25A	EKFL10D1025	EKFL15D10L25	EKFL15D14L25
30A	EKFL10D1030	EKFL15D10L30	EKFL15D14L30
32A	EKFL10D1032	EKFL15D10L32	EKFL15D14L32
35A			EKFL15D14L35
40A			EKFL15D14L40
45A			EKFL15D14L45
50A			EKFL15D14L50

Overall and Installation Dimension(mm)

EKF1-10(X)PV-10

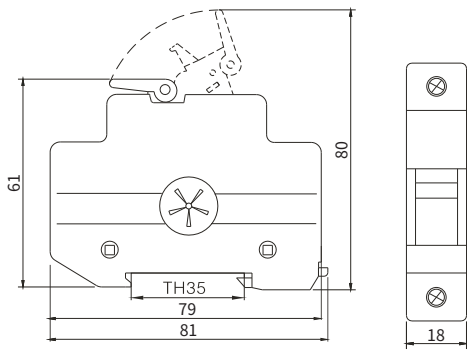

EKF1-10(X)PVH-10

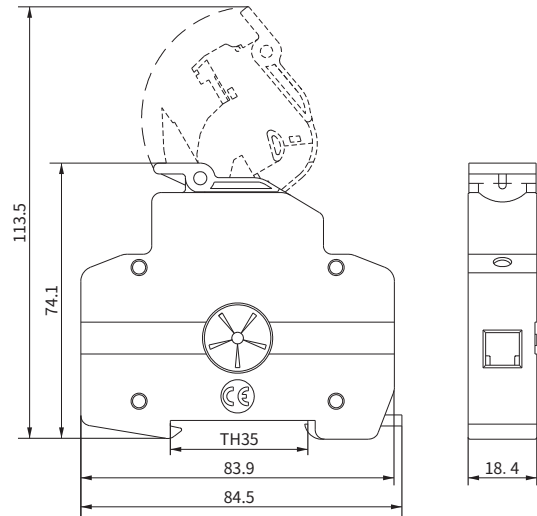

EKF1-15PV-10L/EKF1-15PV-14L

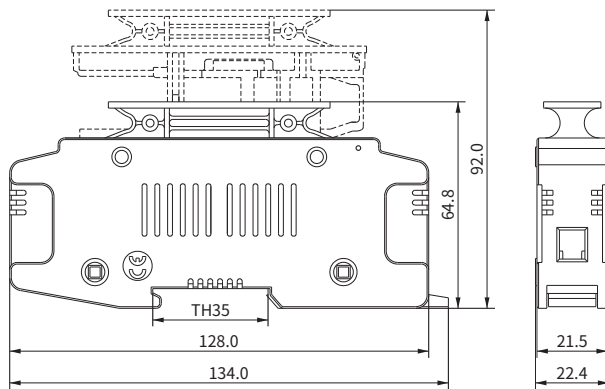

EKFL10D10

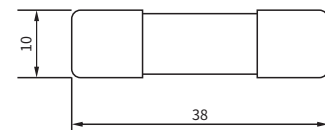

EKFL15D10L

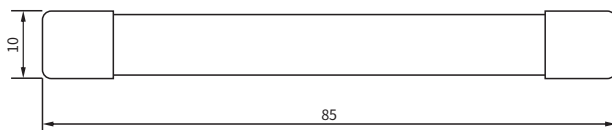

EKFL15D14L

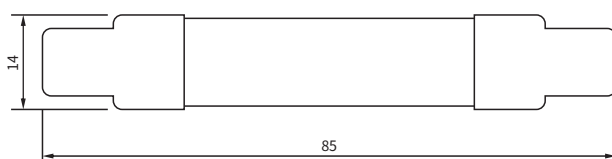

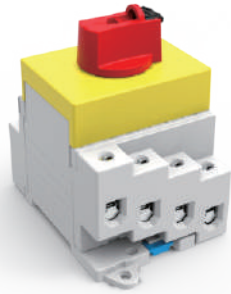

Description

Parallel wiring, larger aperture, much easier wiring.

Suitable for distribution box module with lock installation.

Arc extinction time less than 3ms.

Modular design. 2 poles & 4poles optional.

Comply with IEC60947-3(ed.3.2):2015,DC-PV1standard.

Technical Data

Data according to IEC60947-3(ed.3.2):2015,GB14048.3. Utilization category DC-PV1/DC-PV2								Series	No.of Strings	Part Number	Contact Configuration
500V	600V	700V	800V	900V	1000V	1200V	1500V				
32	32	32	32	23	16	13	7	2	1	EKD6-DB32-2	
58	58	58	45	23	16	13	7	4	1	EKD6-DB32-2H	
32	32	32	32	23	16	13	7	4	2	EKD6-DB32-4	
32	32	32	32	32	32	32	23	4	1	EKD6-DB32-4S	
32	32	32	32	32	32	32	23	4	1	EKD6-DB32-4B	
32	32	32	32	32	32	32	23	4	1	EKD6-DB32-4T	

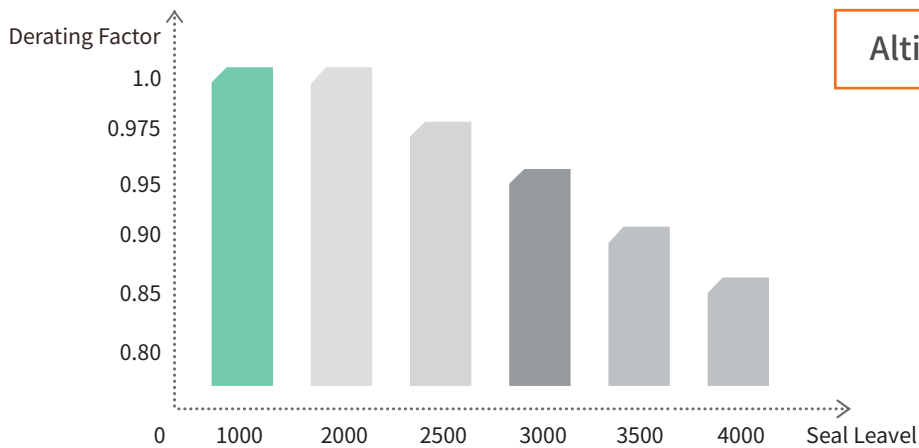

Altitude Derating Curve

Technical Data

Data according to IEC60947-3(ed.3.2):2015,UL508i,GB14048.3. Utilization category DC-PV1 / DC-PV2.

Main Parameters			DB32	
Rated insulation voltage	U_i	V	1500	
Rated thermal current	I_{the}	A	32	
Rated impulse withstand voltage	U_{imp}	V	8000	
Rated short-circuit making capacity	I_{cm}	A	2H	1700
			2, 4	1000
			2H	1700
Rated conditional short-circuit current	I_{cc}	A	5000	
Max. fuse size	$g_L(gG)$	A	80	
Maximum cable cross sections (incl. jumper)				
Solid or standard		mm ²	4-16	
Flexible		mm ²	4-10	
Flexible (+ multicore cable end)		mm ²	4-10	
Torque				
Tightening torque terminal screws M4.		Nm	1.2-1.8	
Tightening torque knob screws M3		Nm	0.5-0.7	
Switching on or off torque		Nm	0.9-1.3	
General parameters				
Method of mounting			Single Hole Mounting	
Type of knob				
Knob positions			OFF at 9 hr, ON at 12 hr	
Mechanical life			10000	
Number of DC poles			2 or 4	
Operation temperature		°C	-40 to +70	
Storage temperature		°C	-40 to +85	
Pollution degree			2	
Overvoltage category			III	
IP rating of shafte and mounting nut			IP66	

Overall and Installation Dimension(mm)

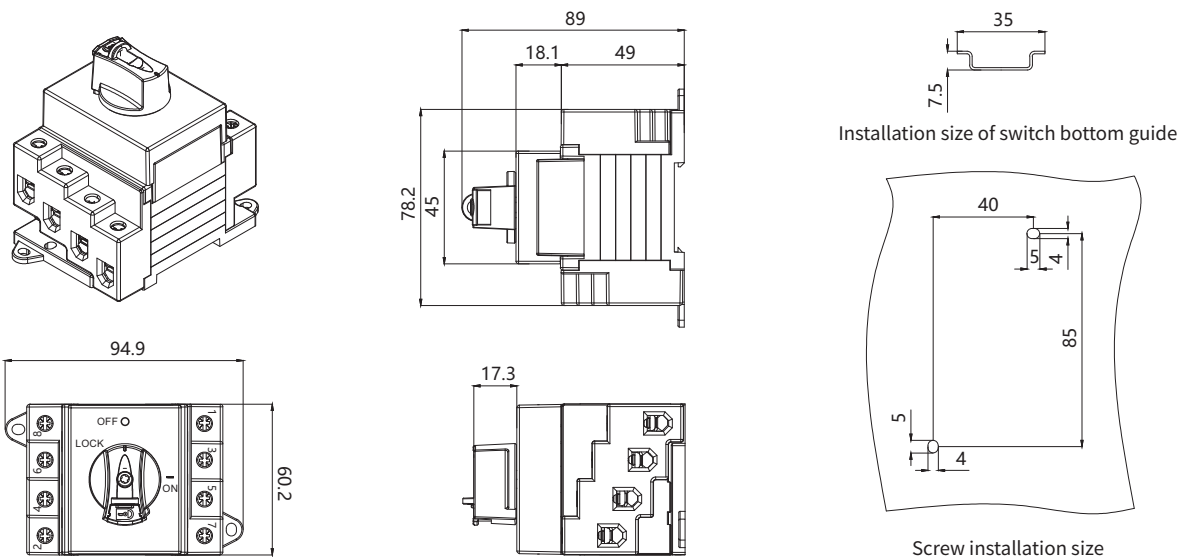



Description

Parallel wiring, larger aperture, much easier wiring.

Suitable for door lock installation.

Arc extinction time less than 3ms.

Modular design. 2 poles & 4poles optional.

Comply with IEC60947-3(ed.3.2):2015,DC-PV1standard.

Technical Data

Data according to IEC60947-3(ed.3.2):2015,GB14048.3. Utilization category DC-PV1/DC-PV2								Series	No.of Strings	Part Number	Contact Configuration
500V	600V	700V	800V	900V	1000V	1200V	1500V				
32	32	32	32	23	16	13	7	2	1	EKD6-DC32-2	
58	58	58	45	23	16	13	7	4	1	EKD6-DC32-2H	
32	32	32	32	23	16	13	7	4	2	EKD6-DC32-4	
32	32	32	32	32	32	32	23	4	1	EKD6-DC32-4S	
32	32	32	32	32	32	32	23	4	1	EKD6-DC32-4B	
32	32	32	32	32	32	32	23	4	1	EKD6-DC32-4T	

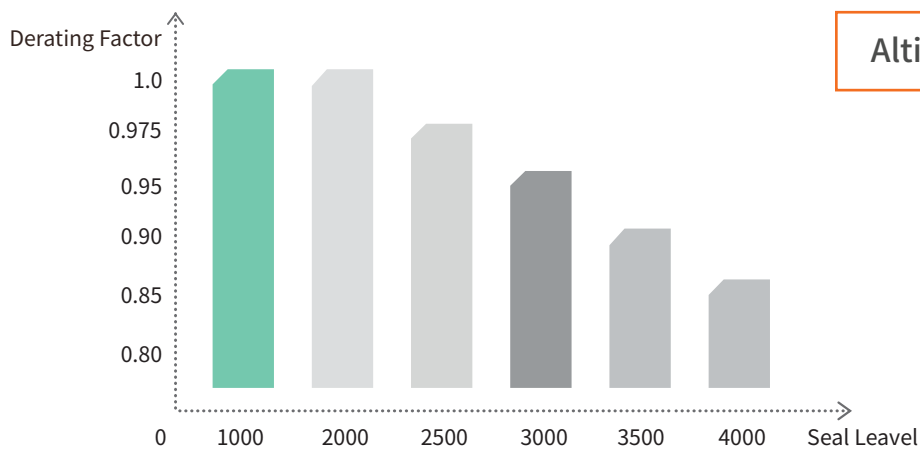

Altitude Derating Curve

Technical Data

Data according to IEC60947-3(ed.3.2):2015,UL508i,GB14048.3. Utilization category DC-PV1 / DC-PV2.

Main Parameters			DC32	
Rated insulation voltage	U_i	V	1500	
Rated thermal current	I_{the}	A	32	
Rated impulse withstand voltage	U_{imp}	V	8000	
Rated short-circuit making capacity	I_{cm}	A	2H	1700
			2, 4	1000
			2H	1700
Rated conditional short-circuit current	I_{cc}	A	5000	
Max. fuse size	$g_L(gG)$	A	80	
Maximum cable cross sections (incl. jumper)				
Solid or standard		mm ²	4-16	
Flexible		mm ²	4-10	
Flexible (+ multicore cable end)		mm ²	4-10	
Torque				
Tightening torque terminal screws M4.		Nm	1.2-1.8	
Tightening torque panel mounting screws ST4.2(304 stainless steel)		Nm	0.8-0.9	
Tightening torque knob screws M3		Nm	0.5-0.7	
Switching on or off torque		Nm	0.9-1.3	
General parameters				
Method of mounting			Single Hole Mounting	
Type of knob			B	
Knob positions			OFF at 12 hr, ON at 3 hr	
Mechanical life			10000	
Number of DC poles			2 or 4	
Operation temperature		°C	-40 to +70	
Storage temperature		°C	-40 to +85	
Pollution degree			2	
Overvoltage category			III	
IP rating of shafte and mounting nut			IP66	

Overall and Installation Dimension(mm)

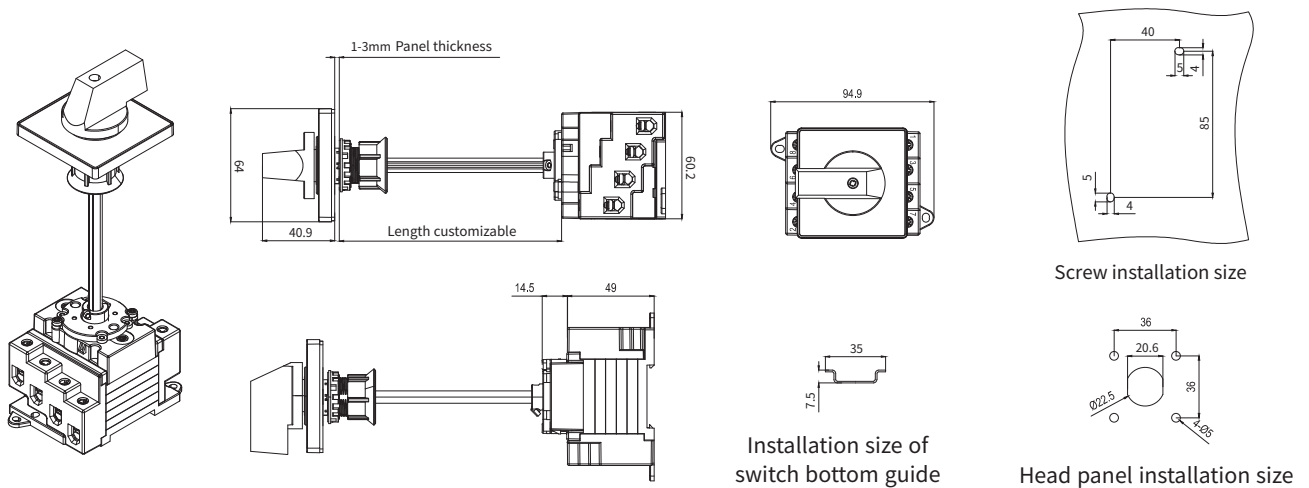



Description

Parallel wiring, larger aperture, much easier wiring.

Suitable for door lock installation.

Arc extinction time less than 3ms.

Modular design. 2 poles & 4poles optional.

The handle locked in "OFF" position.

Comply with IEC60947-3(ed.3.2):2015,DC-PV1standard.

Technical Data

Data according to IEC60947-3(ed.3.2):2015,GB14048.3. Utilization category DC-PV1/DC-PV2								Series	No.of Strings	Part Number	Contact Configuration
500V	600V	700V	800V	900V	1000V	1200V	1500V				
32	32	32	32	23	16	13	7	2	1	EKD6-DC32R-2	
58	58	58	45	23	16	13	7	4	1	EKD6-DC32R-2H	
32	32	32	32	23	16	13	7	4	2	EKD6-DC32R-4	
32	32	32	32	32	32	32	23	4	1	EKD6-DC32R-4S	
32	32	32	32	32	32	32	23	4	1	EKD6-DC32R-4B	
32	32	32	32	32	32	32	23	4	1	EKD6-DC32R-4T	

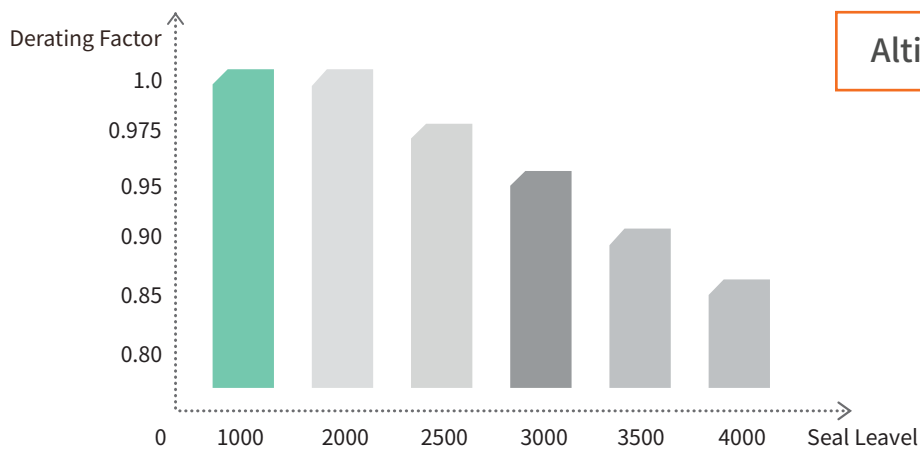

Altitude Derating Curve

Technical Data

Data according to IEC60947-3(ed.3.2):2015,UL508i,GB14048.3. Utilization category DC-PV1 / DC-PV2.

Main Parameters			DC32R	
Rated insulation voltage	U_i	V	1500	
Rated thermal current	I_{the}	A	32	
Rated impulse withstand voltage	U_{imp}	V	8000	
Rated short-circuit making capacity	I_{cm}	A	2H	1700
			2, 4	1000
			2H	1700
Rated conditional short-circuit current	I_{cc}	A	5000	
Max. fuse size	g_L (gG)	A	80	
Maximum cable cross sections (incl. jumper)				
Solid or standard		mm ²	4-16	
Flexible		mm ²	4-10	
Flexible (+ multicore cable end)		mm ²	4-10	
Torque				
Tightening torque terminal screws M4.		Nm	1.2-1.8	
Tightening torque panel mounting screws ST4.2(304 stainless steel)		Nm	0.8-0.9	
Tightening torque knob screws M3		Nm	0.5-0.7	
Switching on or off torque		Nm	0.9-1.3	
General parameters				
Method of mounting			Single Hole Mounting	
Type of knob				
Knob positions			OFF at 12 hr, ON at 3 hr	
Mechanical life			10000	
Number of DC poles			2 or 4	
Operation temperature		°C	-40 to +70	
Storage temperature		°C	-40 to +85	
Pollution degree			2	
Overvoltage category			III	
IP rating of shafte and mounting nut			IP66	

Overall and Installation Dimension(mm)

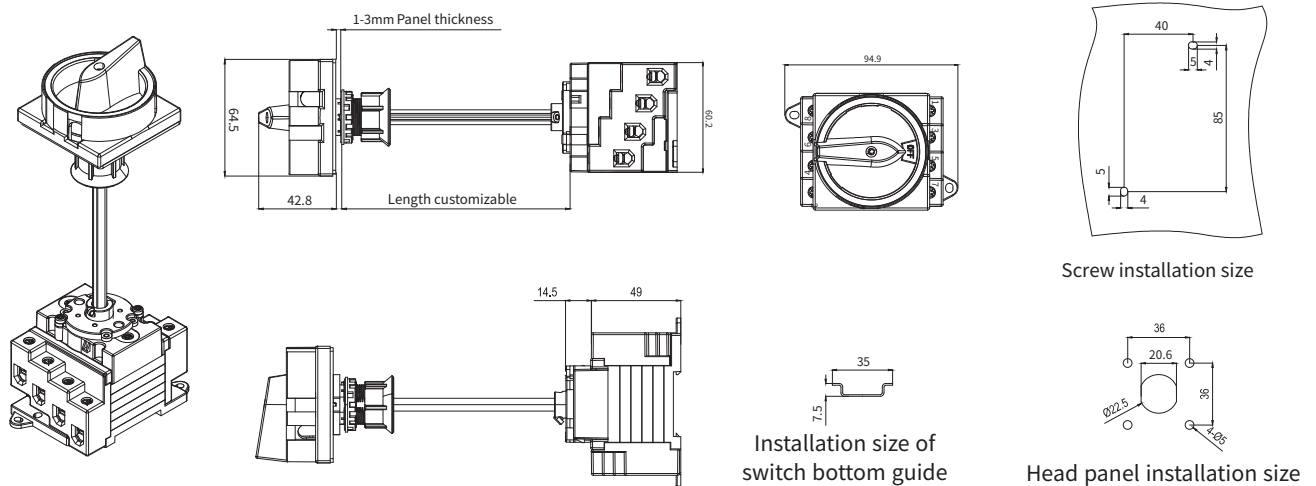



Description

Parallel wiring, larger aperture, much easier wiring.

Suitable for panel mounting.

Arc extinction time less than 3ms.

Modular design. 2 poles & 4poles optional.

Comply with IEC60947-3(ed.3.2):2015,DC-PV1standard.

Technical Data

Data according to IEC60947-3(ed.3.2):2015,GB14048.3. Utilization category DC-PV1/DC-PV2								Series	No.of Strings	Part Number	Contact Configuration
500V	600V	700V	800V	900V	1000V	1200V	1500V				
32	32	32	32	23	16	13	7	2	1	EKD6-PM32-2	
58	58	58	45	23	16	13	7	4	1	EKD6-PM32-2H	
32	32	32	32	23	16	13	7	4	2	EKD6-PM32-4	
32	32	32	32	32	32	32	23	4	1	EKD6-PM32-4S	
32	32	32	32	32	32	32	23	4	1	EKD6-PM32-4B	
32	32	32	32	32	32	32	23	4	1	EKD6-PM32-4T	

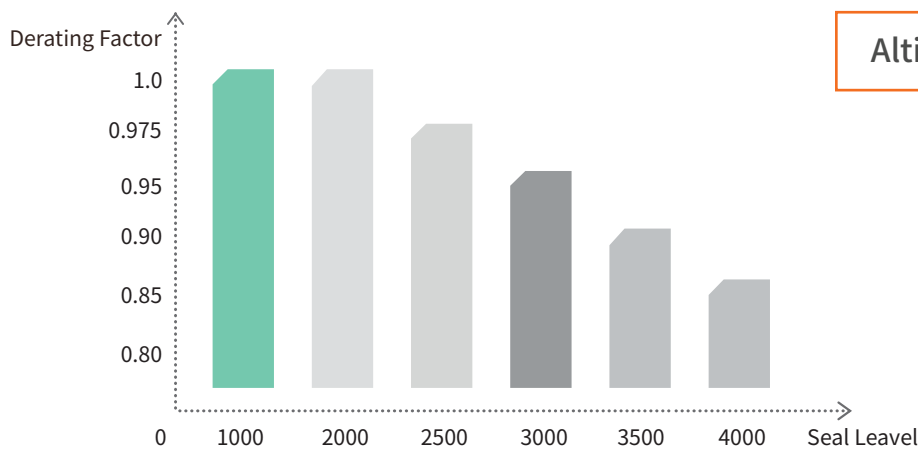

Altitude Derating Curve

Technical Data

Data according to IEC60947-3(ed.3.2):2015,UL508i,GB14048.3. Utilization category DC-PV1 / DC-PV2.

Main Parameters			PM32	
Rated insulation voltage	U_i	V	1500	
Rated thermal current	I_{the}	A	32	
Rated impulse withstand voltage	U_{imp}	V	8000	
Rated short-circuit making capacity	I_{cm}	A	2H	1700
			2, 4	1000
			2H	1700
Rated conditional short-circuit current	I_{cc}	A	5000	
Max. fuse size	$g_L(gG)$	A	80	
Maximum cable cross sections (incl. jumper)				
Solid or standard		mm ²	4-16	
Flexible		mm ²	4-10	
Flexible (+ multicore cable end)		mm ²	4-10	
Torque				
Tightening torque terminal screws M4.		Nm	1.2-1.8	
Tightening torque panel mounting screws ST4.2(304 stainless steel)		Nm	0.8-0.9	
Tightening torque knob screws M3		Nm	0.5-0.7	
Switching on or off torque		Nm	0.9-1.3	
General parameters				
Method of mounting			Single Hole Mounting	
Type of knob			B 	
Knob positions			OFF at 12 hr, ON at 3 hr	
Mechanical life			10000	
Number of DC poles			2 or 4	
Operation temperature		°C	-40 to +70	
Storage temperature		°C	-40 to +85	
Pollution degree			2	
Overvoltage category			III	
IP rating of shafte and mounting nut			IP66	

Overall and Installation Dimension(mm)

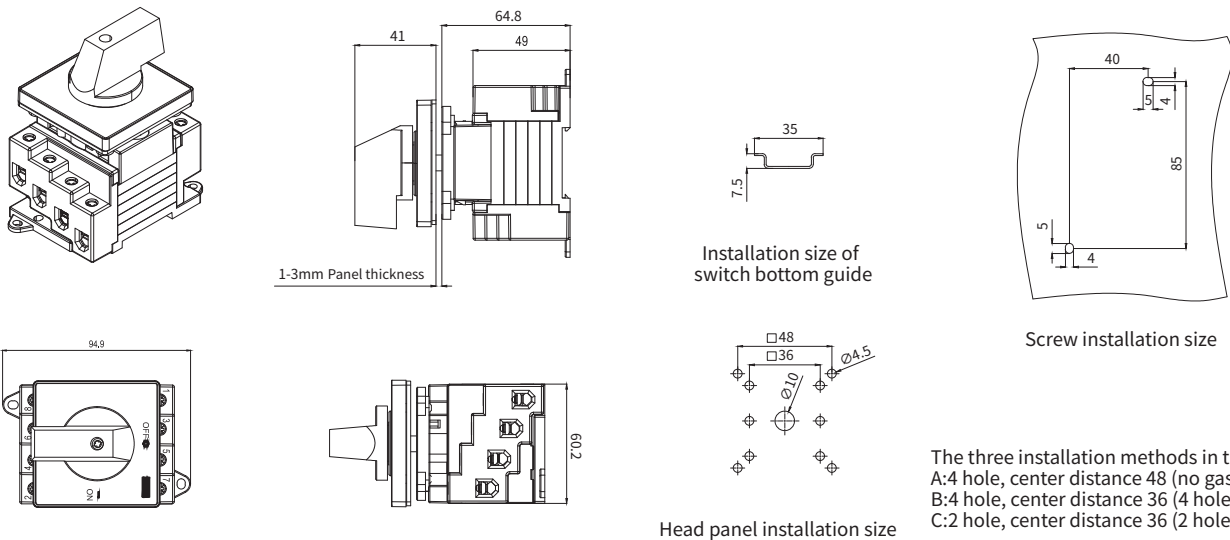



Description

Parallel wiring, larger aperture, much easier wiring.

Suitable for panel mounting.

Arc extinction time less than 3ms.

Modular design. 2 poles & 4poles optional.

The handle locked in "OFF" position.

Comply with IEC60947-3(ed.3.2):2015,DC-PV1standard.

Technical Data

Data according to IEC60947-3(ed.3.2):2015,GB14048.3. Utilization category DC-PV1/DC-PV2								Series	No.of Strings	Part Number	Contact Configuration
500V	600V	700V	800V	900V	1000V	1200V	1500V				
32	32	32	32	23	16	13	7	2	1	EKD6-PM32R-2	
58	58	58	45	23	16	13	7	4	1	EKD6-PM32R-2H	
32	32	32	32	23	16	13	7	4	2	EKD6-PM32R-4	
32	32	32	32	32	32	32	23	4	1	EKD6-PM32R-4S	
32	32	32	32	32	32	32	23	4	1	EKD6-PM32R-4B	
32	32	32	32	32	32	32	23	4	1	EKD6-PM32R-4T	

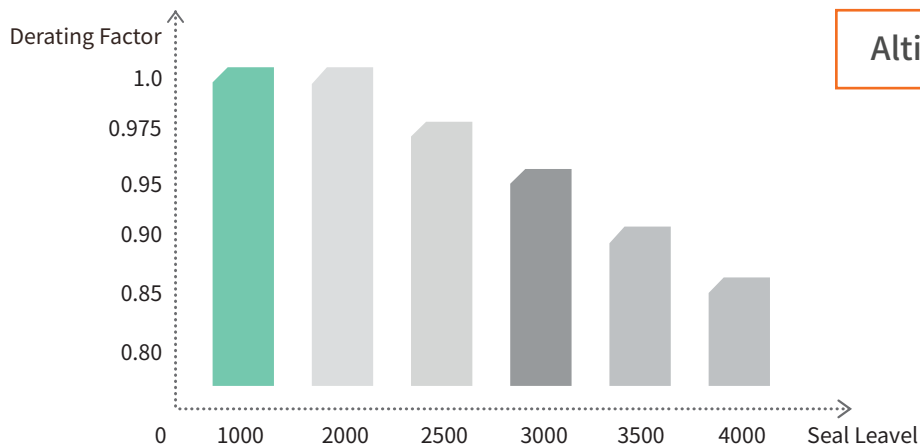

Altitude Derating Curve

Technical Data

Data according to IEC60947-3(ed.3.2):2015,UL508i,GB14048.3. Utilization category DC-PV1 / DC-PV2.

Main Parameters			PM32R	
Rated insulation voltage	U_i	V	1500	
Rated thermal current	I_{the}	A	32	
Rated impulse withstand voltage	U_{imp}	V	8000	
Rated short-circuit making capacity	I_{cm}	A	2H	1700
			2, 4	1000
			2H	1700
Rated conditional short-circuit current	I_{cc}	A	5000	
Max. fuse size	g_L (gG)	A	80	
Maximum cable cross sections (incl. jumper)				
Solid or standard		mm ²	4-16	
Flexible		mm ²	4-10	
Flexible (+ multicore cable end)		mm ²	4-10	
Torque				
Tightening torque terminal screws M4.		Nm	1.2-1.8	
Tightening torque panel mounting screws ST4.2(304 stainless steel)		Nm	0.8-0.9	
Tightening torque knob screws M3		Nm	0.5-0.7	
Switching on or off torque		Nm	0.9-1.3	
General parameters				
Method of mounting			Single Hole Mounting	
Type of knob				
Knob positions			OFF at 12 hr, ON at 3 hr	
Mechanical life			10000	
Number of DC poles			2 or 4	
Operation temperature		°C	-40 to +70	
Storage temperature		°C	-40 to +85	
Pollution degree			2	
Overvoltage category			III	
IP rating of shafte and mounting nut			IP66	

Overall and Installation Dimension(mm)

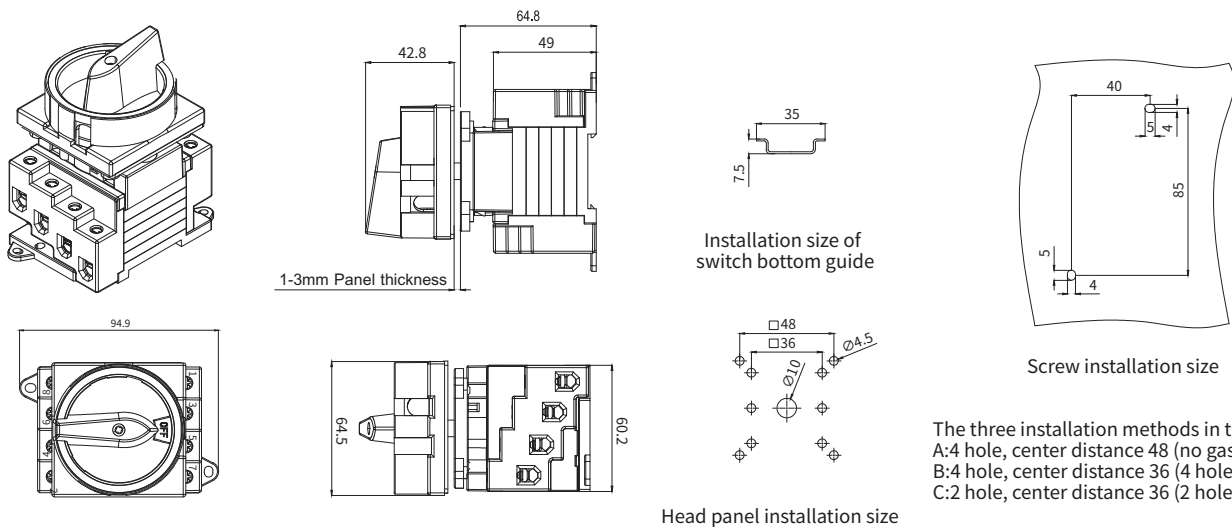



Description

IP66 box-type design:

- ◆ Screw fixing doesn't interfere with the sealing performance;
- ◆ Multiple mechanical seals around the shaft guarantee the reliability of a waterproof and moisture-proof design;
- ◆ Stainless steel rotary screw does not rust nor damp;
- ◆ Standard cable interface available with seal rings;
- ◆ Internal sealing in top and bottom covers, combined with 2 screws, guarantee an IP66 protection degree;

SAFE-LOCK with three rotational positions, reducing the risk of tampering.

The isolator is compatible with various cables: M25, M20, M16, and M12, and with optional waterproof cable joints and MC4 joints.



Characteristics of the integration inside the on/of switch:

- ◆ Compact structure, with optional 2 or 4 DC poles;
- ◆ Incorporating a user independent switching action, spring mechanism, to ensure a very fast break/make action, ensuring that the disconnection of the load circuits and suppression of the arc normally occurs within 5ms.
- ◆ Self-cleaning contact mechanism, reducing power loss and abrasion, improving the conduction performance, reducing the resistance and energy loss of the switch, extending the on-off lifecycle.
- ◆ Double arc extinguishing mechanism, magnetic and arc chutes, restrain the arc efficiency, especially DC arcs.

Technical Data

Data according to IEC60947-3(ed.3.2):2015,GB14048.3. Utilization category DC-PV1/DC-PV2								Series	No.of Strings	Part Number	Contact Configuration
500V	600V	700V	800V	900V	1000V	1200V	1500V				
32	32	32	32	23	16	13	7	2	1	EKD6-EL32R-2	
58	58	58	45	23	16	13	7	4	1	EKD6-EL32R-2H	
32	32	32	32	23	16	13	7	4	2	EKD6-EL32R-4	
32	32	32	32	32	32	32	23	4	1	EKD6-EL32R-4S	
32	32	32	32	32	32	32	23	4	1	EKD6-EL32R-4B	
32	32	32	32	32	32	32	23	4	1	EKD6-EL32R-4T	

Technical Data

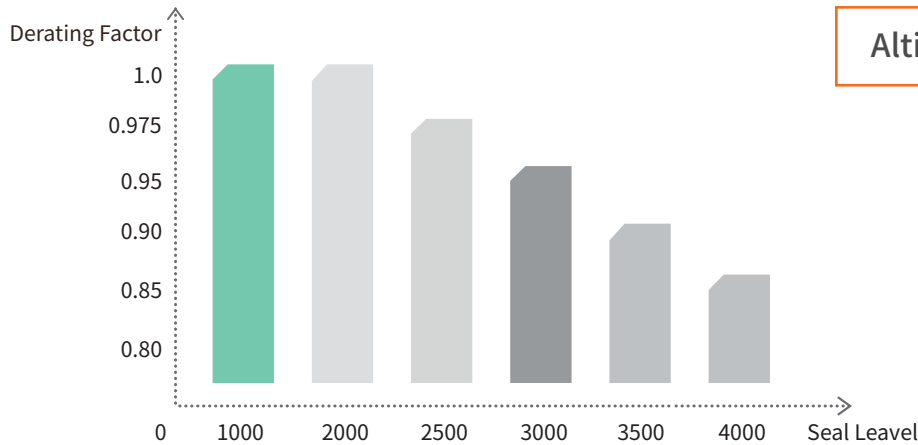

Altitude Derating Curve

Data according to IEC60947-3(ed.3.2):2015,UL508i,GB14048.3. Utilization category DC-PV1 / DC-PV2.

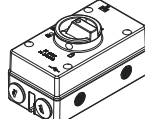
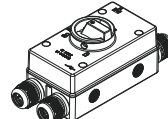
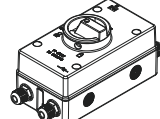
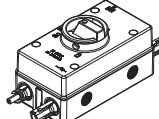
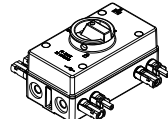
Main Parameters			EL32R		
Rated insulation voltage	U_i	V	1500		
Rated thermal current	I_{the}	A	32		
Rated impulse withstand voltage	U_{imp}	V	8000		
Rated short-circuit making capacity	I_{cm}	A	2H	1700	
			2, 4	1000	
Rated conditional short-circuit current	I_{cc}	A	5000		
Max. fuse size	g_L (gG)	A	80		
Maximum cable cross sections (incl. jumper)					
Solid or standard		mm ²	4-16		
Flexible		mm ²	4-10		
Flexible (+ multicore cable end)		mm ²	4-10		
Torque					
Tightening torque terminal screws M4.		Nm	1.2-1.8		
Tightening torque panel mounting screws ST4.2(304 stainless steel)		Nm	1.5-2.0		
Tightening torque knob screws M3		Nm	0.5-0.7		
Switching on or off torque		Nm	0.9-1.3		
General parameters					
Method of mounting	Wall-mounted or screw installation				
Type of knob					
Knob positions	OFF at 9 hr, ON at 12 hr				
Mechanical life	10000				
Number of DC poles	2 or 4				
Distance of contacts (per pole)	8				
Operation temperature		°C	-40 to +70		
Storage temperature		°C	-40 to +85		
Pollution degree	2				
Overvoltage category	III				
IP rating of shafte and mounting nut	IP66				
Types					
					
Specs	M25 Waterproof Cap	Cable Gland M25	Cable Gland M16	2MC4/H4(Optional)	4MC4/H4(Optional)
Independent Strings	1 or 2	1 or 2	1	1	1
Recommend Types	ALL	ALL	2/2H/4S/4T/4B	2/2H/4S/4T/4B	4

Overall and Installation Dimension(mm)

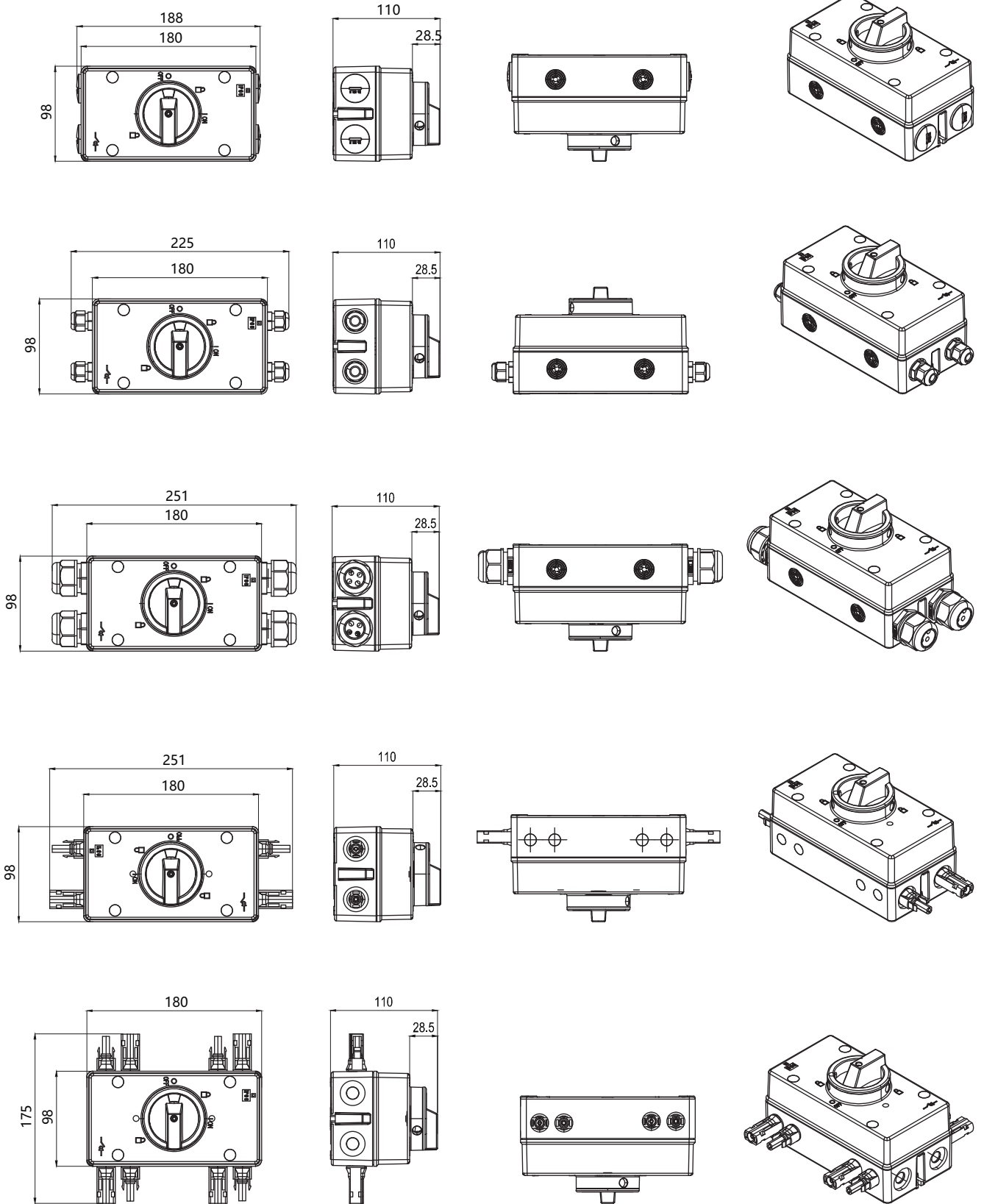

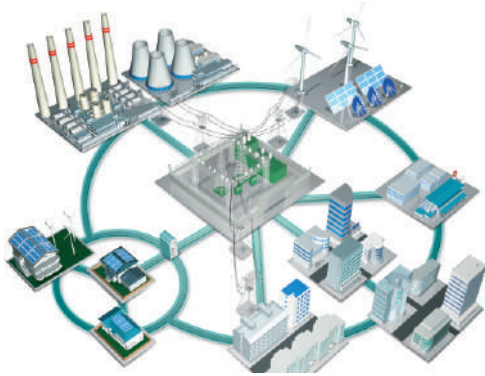

Description

Features

- ♦ Finger-safe fuse holders
- ♦ IP65 Box with Polycarbonate material with Anti UV
- ♦ 5 Years warranty standard

Options

- ♦ AC switch off, DC will switch off Automatically(optional)
- ♦ 1~36 strings boxes available
- ♦ 1500V components available
- ♦ Customizable Upon Request

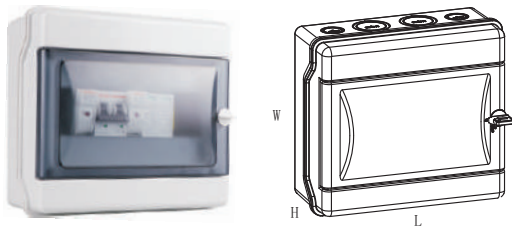

L: 219 W: 200 H: 108 (mm)

1 String Input 1 String Output DC 600V

Type	EKDB-PV1/1-600-M	Quantity
Encloser of Box	EKDB4P9RS	1
DC SPD	EKU5-40Z-2-600	1
DC MCB	EKM1-63DC-216 2P 600VDC	1
DC Fuse with Link	EKF1-10XPVH-10-1P 15A 1000V	2

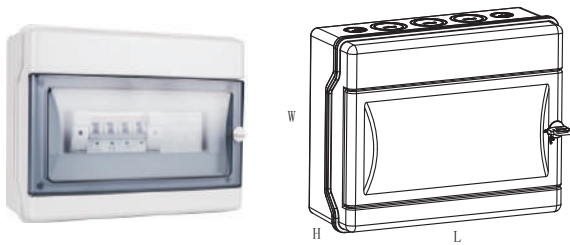
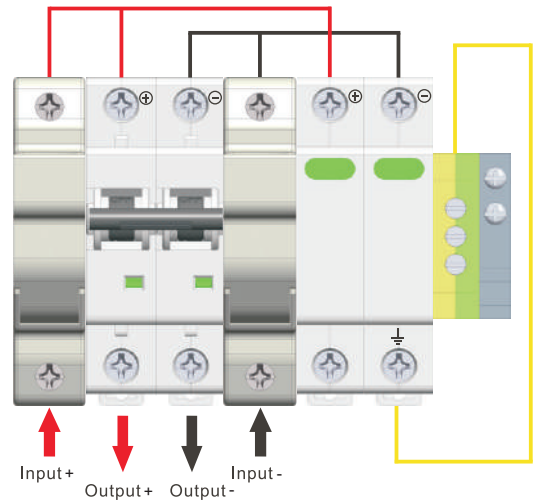

L: 273 W: 215 H: 112 (mm)

1 String Input 1 String Output DC 1000V

Type	EKDB-PV1/1-1000-M	Quantity
Encloser of Box	EKDB4P12RS	1
DC SPD	EKU5-40Z-3-1000	1
DC MCB	EKM1-63DC-416 4P 1000VDC	1
DC Fuse with Link	EKF1-10XPVH-10-1P 15A 1000V	2

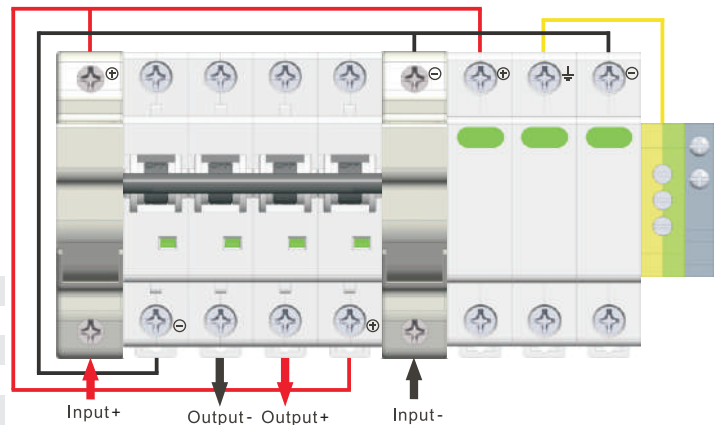

String Box DC

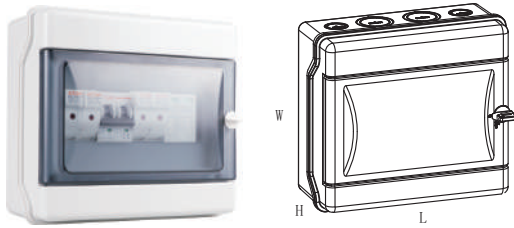

L: 219 W: 200 H: 108 (mm)

2 String Input 1 String Output DC 600V

Type	EKDB-PV2/1-600-M	Quantity
Enclosure of Box	EKDB4P9RS	1
DC SPD	EKU5-40Z-2-600	1
DC MCB	EKM1-63DC-232 2P 600VDC	1
DC Fuse with Link	EKF1-10XPVH-10-1P 15A 1000V	4

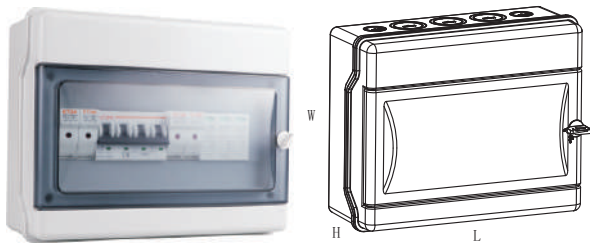
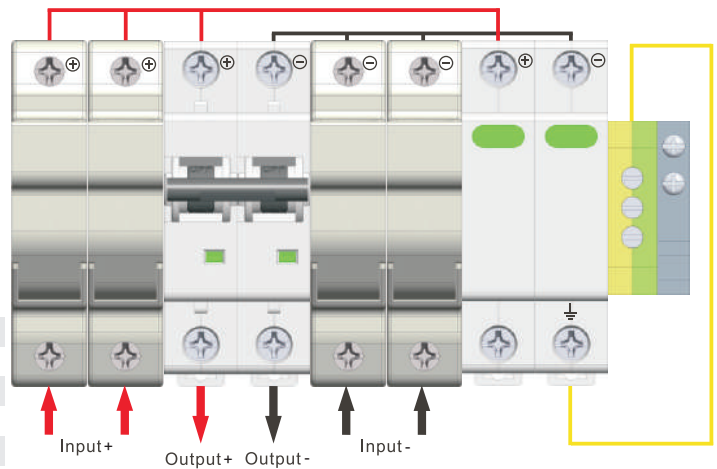

L: 273 W: 215 H: 112 (mm)

2 String Input 1 String Output DC 1000V

Type	EKDB-PV2/1-1000-M	Quantity
Enclosure of Box	EKDB4P12RS	1
DC SPD	EKU5-40Z-3-1000	1
DC MCB	EKM1-63DC-432 4P 1000VDC	1
DC Fuse with Link	EKF1-10XPVH-10-1P 15A 1000V	4

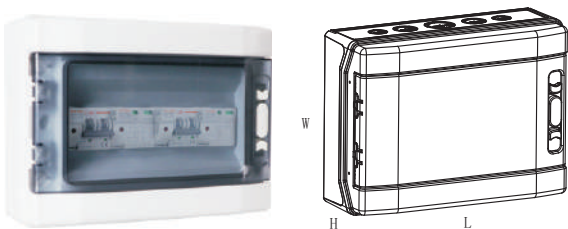
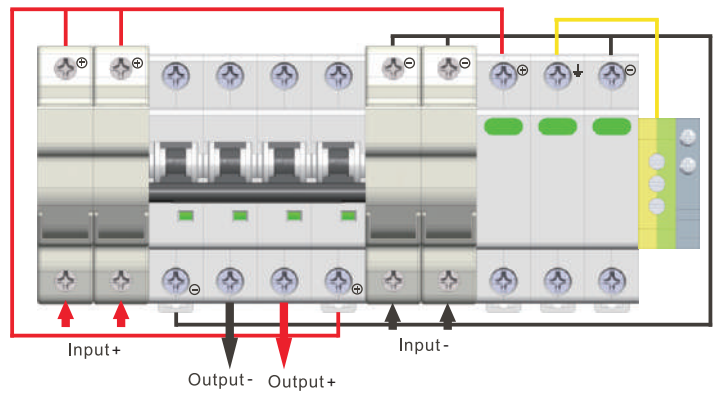

L: 310 W: 230.5 H: 115 (mm)

2 String Input 2 String Output DC 600V

Type	EKDB-PV2/2-600-M	Quantity
Enclosure of Box	EKDB4P12R	1
DC SPD	EKU5-40Z-2-600	2
DC MCB	EKM1-63DC-216 2P 600VDC	2
DC Fuse with Link	EKF1-10XPVH-10-1P 15A 1000V	4

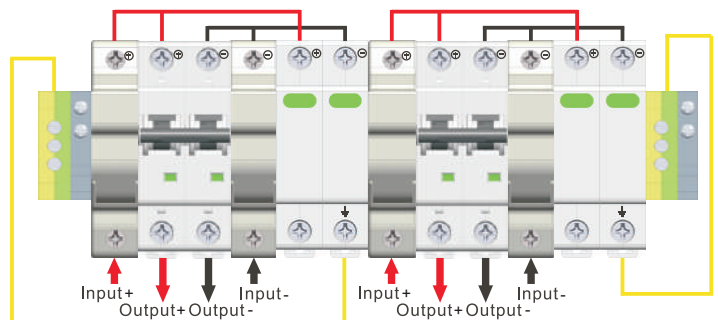

String Box DC

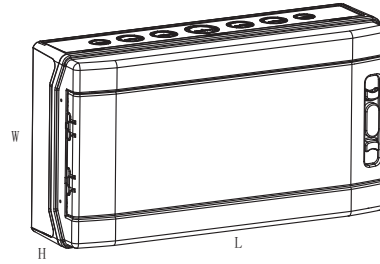

L: 417 W: 230.5 H: 113 (mm)

2 String Input 2 String Output DC 1000V

Type	EKDB-PV2/2-1000-M	Quantity
Enclosure of Box	EKDB4P18R	1
DC SPD	EKU5-40Z-3-1000	2
DC MCB	EKM1-63DC-416 4P 1000VDC	2
DC Fuse with Link	EKF1-10XPVH-10-1P 15A 1000V	4

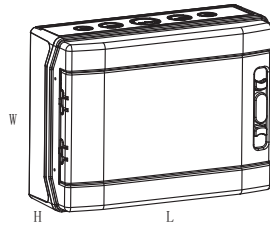
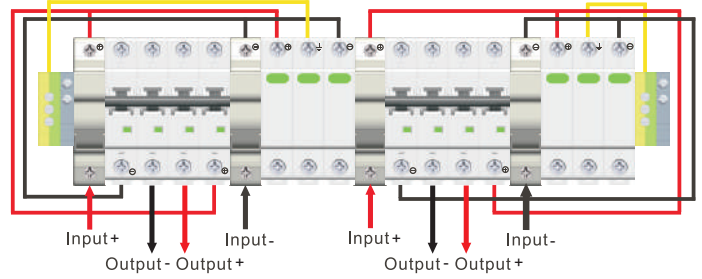

L: 310 W: 230.5 H: 115 (mm)

4 String Input 1 String Output DC 600V

Type	EKDB-PV4/1-600-M	Quantity
Enclosure of Box	EKDB4P12R	1
DC SPD	EKU5-40Z-2-600	1
DC MCB	EKM1-63DC-263 2P 600VDC	1
DC Fuse with Link	EKF1-10XPVH-10-1P 15A 1000V	8

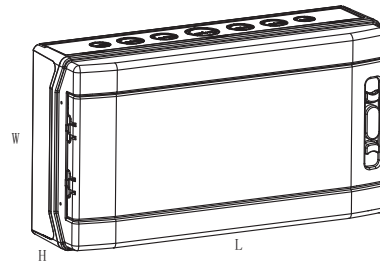
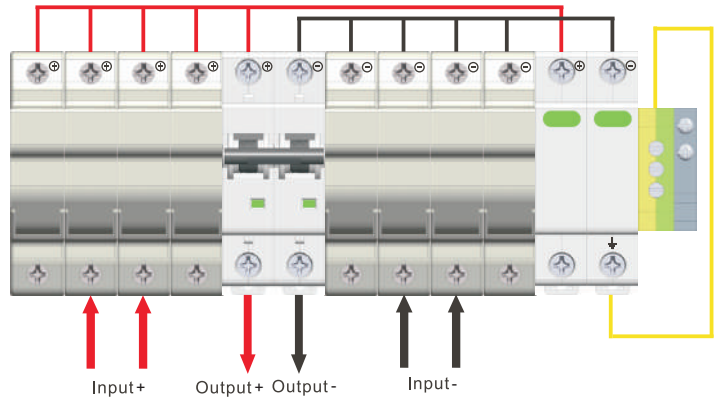

L: 417 W: 230.5 H: 113 (mm)

4 String Input 1 String Output DC 1000V

Type	EKDB-PV4/1-1000-M	Quantity
Enclosure of Box	EKDB4P18R	1
DC SPD	EKU5-40Z-3-1000	1
DC MCB	EKM1-63DC-463 4P 1000VDC	1
DC Fuse with Link	EKF1-10XPVH-10-1P 15A 1000V	8

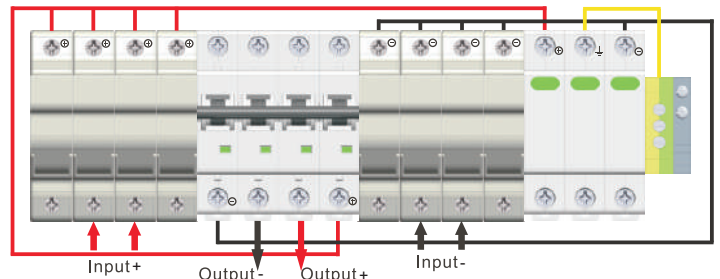

String Box DC

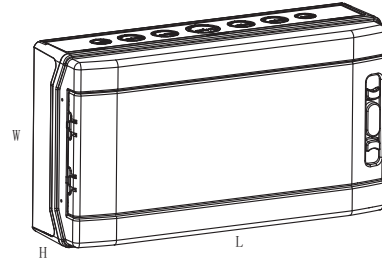

L: 417 W: 230.5 H: 113 (mm)

4 String Input 2 String Output DC 600V

Type	EKDB-PV4/2-600-M	Quantity
Enclosure of Box	EKDB4P18R	1
DC SPD	EKU5-40Z-2-600	2
DC MCB	EKM1-63DC-232 2P 600VDC	2
DC Fuse with Link	EKF1-10XPVH-10-1P 15A 1000V	8

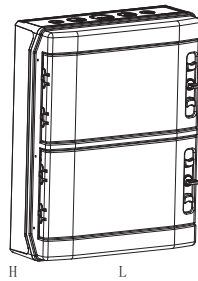
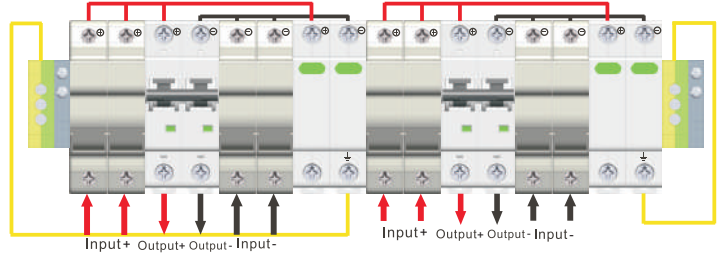

L: 309 W: 392 H: 115 (mm)

4 String Input 2 String Output DC 1000V

Type	EKDB-PV4/2-1000-M	Quantity
Enclosure of Box	EKDB4P24R	1
DC SPD	EKU5-40Z-3-1000	2
DC MCB	EKM1-63DC-432 4P 1000VDC	2
DC Fuse with Link	EKF1-10XPVH-10-1P 15A 1000V	8

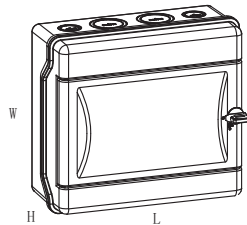
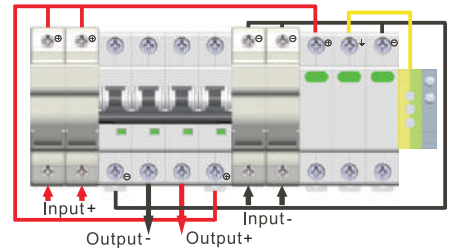
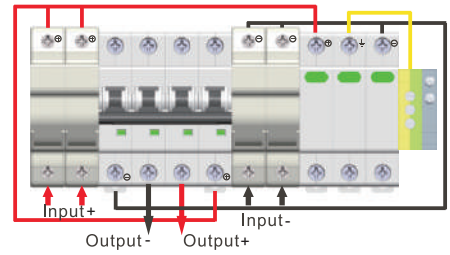

L: 219 W: 200 H: 108 (mm)

1 String Input 1 String Output DC 600V

Type	EKDB-PV1/1-600-I	Quantity
Enclosure of Box	EKDB4P9RS	1
DC SPD	EKU5-40Z-2-600	1
DC Isolator	EKD6-DB32-2	1
DC Fuse with Link	EKF1-10XPVH-10-1P 15A 1000V	2

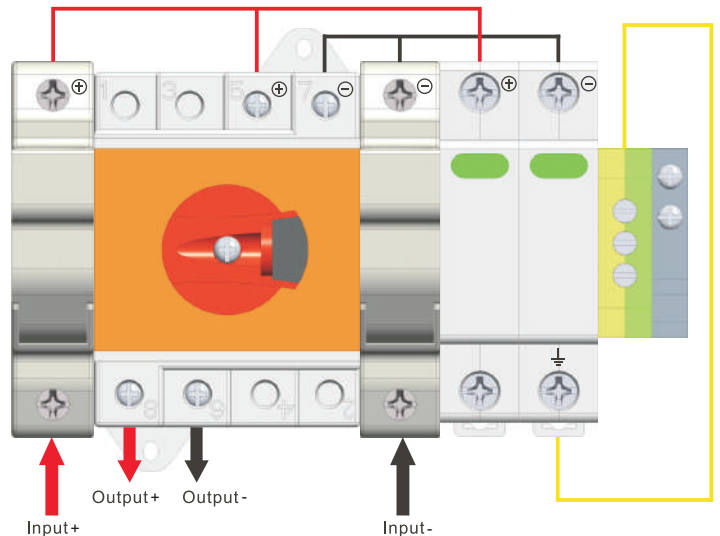

String Box DC

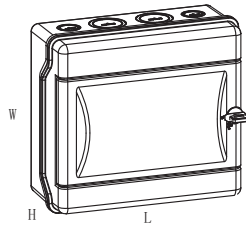

L: 219 W: 200 H: 108 (mm)

1 String Input 1 String Output DC 1000V

Type	EKDB-PV1/1-1000-I	Quantity
Encloser of Box	EKDB4P9RS	1
DC SPD	EKU5-40Z-3-1000	1
DC Isolator	EKD6-DB32-4S	1
DC Fuse with Link	EKF1-10XPVH-10-1P 15A 1000V	2

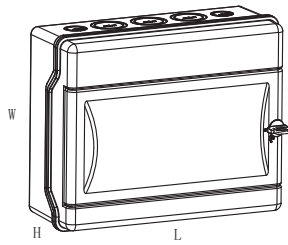
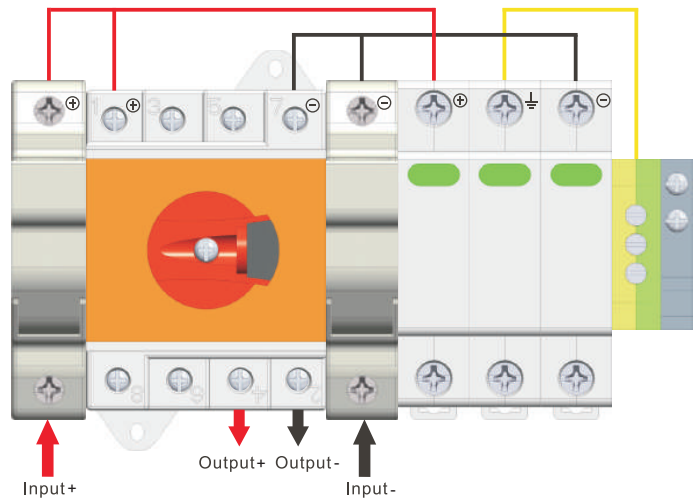

L: 273 W: 215 H: 112 (mm)

2 String Input 1 String Output DC 600V

Type	EKDB-PV2/1-600-I	Quantity
Encloser of Box	EKDB4P12RS	1
DC SPD	EKU5-40Z-2-600	1
DC Isolator	EKD6-DB32-2	1
DC Fuse with Link	EKF1-10XPVH-10-1P 15A 1000V	4

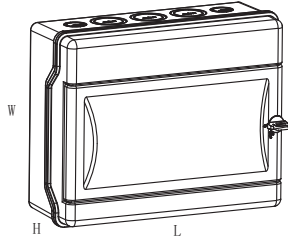
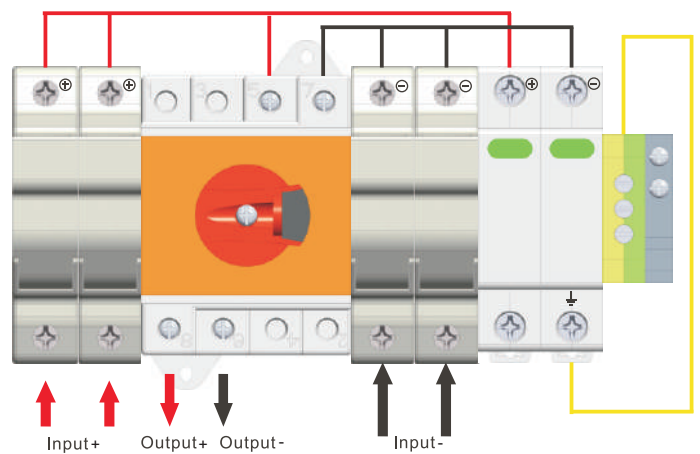

L: 273 W: 215 H: 112 (mm)

2 String Input 1 String Output DC 1000V

Type	EKDB-PV2/1-1000-I	Quantity
Encloser of Box	EKDB4P12RS	1
DC SPD	EKU5-40Z-3-1000	1
DC Isolator	EKD6-DB32-4S	1
DC Fuse with Link	EKF1-10XPVH-10-1P 15A 1000V	4

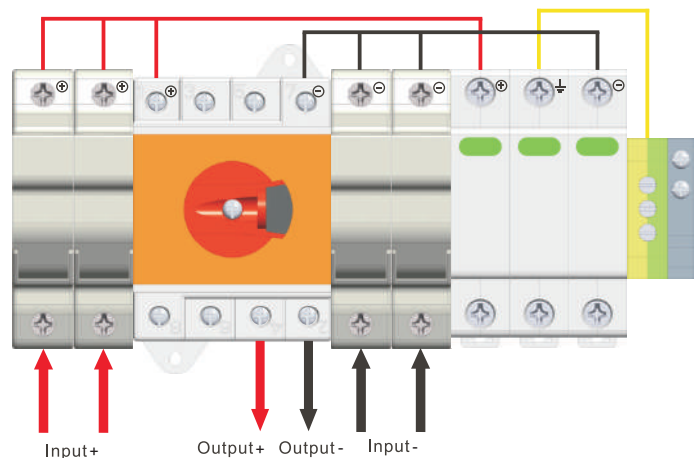

String Box DC

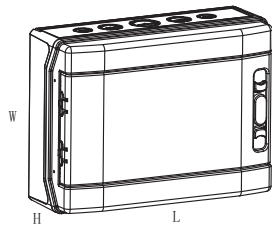

L: 310 W: 230.5 H: 115 (mm)

2 String Input 2 String Output DC 600V

Type	EKDB-PV2/2-600-I	Quantity
Enclosure of Box	EKDB4P12R	1
DC SPD	EKU5-40Z-2-600	2
DC Isolator	EKD6-DB32-4	1
DC Fuse with Link	EKF1-10XPVH-10-1P 15A 1000V	4

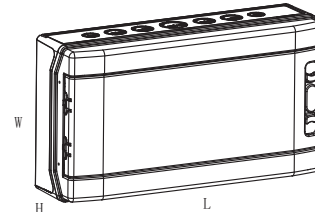
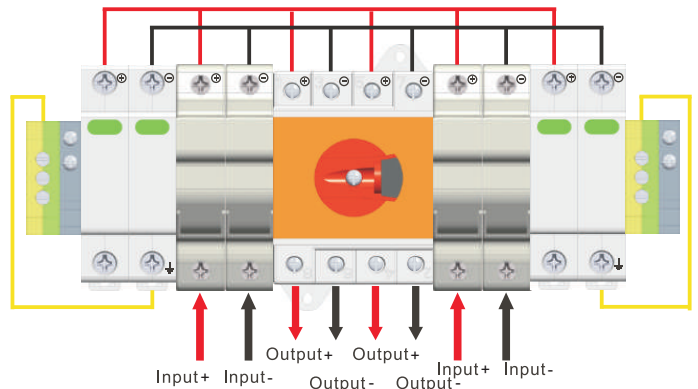

L: 417 W: 230.5 H: 113 (mm)

2 String Input 2 String Output DC 1000V

Type	EKDB-PV2/2-1000-I	Quantity
Enclosure of Box	EKDB4P18R	1
DC SPD	EKU5-40Z-3-1000	2
DC Isolator	EKD6-DB32-4S	2
DC Fuse with Link	EKF1-10XPVH-10-1P 15A 1000V	4

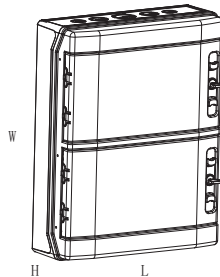
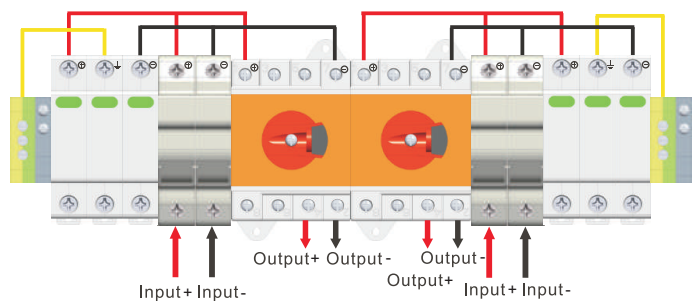

L: 309 W: 392 H: 115 (mm)

4 String Input 2 String Output DC 600V

Type	EKDB-PV4/2-600-I	Quantity
Enclosure of Box	EKDB4P24R	1
DC SPD	EKU5-40Z-2-600	2
DC Isolator	EKD6-DB32-2	2
DC Fuse with Link	EKF1-10XPVH-10-1P 15A 1000V	8

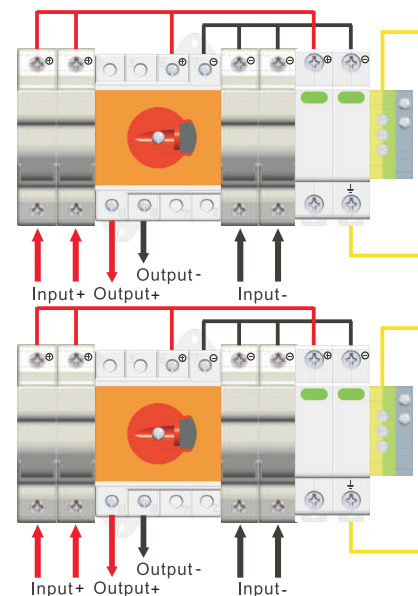

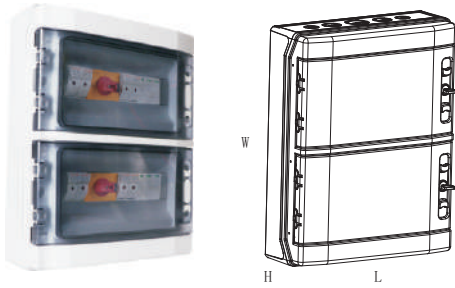

L: 309 W: 392 H: 115 (mm)

4 String Input 2 String Output DC 1000V

Type	EKDB-PV4/2-1000-I	Quantity
Enclosure of Box	EKDB4P24R	1
DC SPD	EKU5-40Z-3-1000	2
DC Isolator	EKD6-DB32-4S	2
DC Fuse with Link	EKF1-10XPVH-10-1P 15A 1000V	8

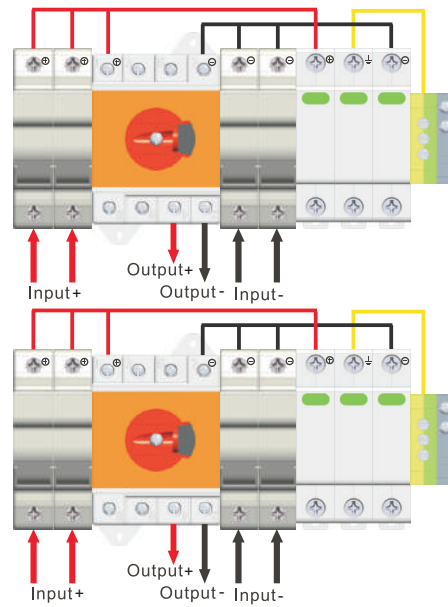



Description

ETEK wall-mounted injection molding sealed box series products are made of impact-resistant polycarbonate PC or ABS material injection molding, and its air tightness can be applied to harsh and harsh industrial environments, protection, etc. The class can reach IP65; the cabinet can be equipped with related accessories, which can be easily installed horizontally or vertically as required. The front panel (inside door) can also be installed. The bottom panel can be made of plastic or metal. This product can be widely used in photovoltaic solar energy, Petrochemical steel mines, subway tunnels and other areas with harsh environments.

Model meaning of FRP plastic sealed box

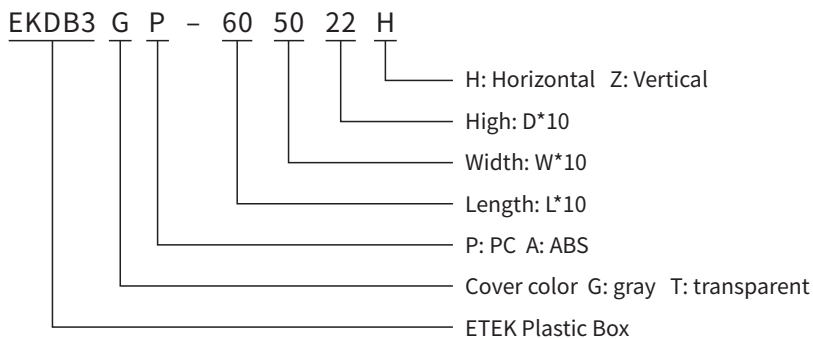

Main Technical Data

Model No.		Dimension(mm)					
		Length	width	height	Available depth	Base plate installation	Wall installation
PC	ABS	L	W	D	C	B×A	E×S
EKDB3G(T)P-605022H	EKDB3G(T)A-605022H	600	500	220	148	560×460	560×515
EKDB3G(T)P-605022Z	EKDB3G(T)A-605022Z	600	500	220	148	560×460	615×460
EKDB3G(T)P-604022H	EKDB3G(T)A-604022H	600	400	220	148	560×360	560×415
EKDB3G(T)P-604022Z	EKDB3G(T)A-604022Z	600	400	220	148	560×360	615×360
EKDB3G(T)P-504020H	EKDB3G(T)A-504020H	500	400	200	128	460×360	460×415
EKDB3G(T)P-504020Z	EKDB3G(T)A-504020Z	500	400	200	128	460×360	515×360
EKDB3G(T)P-403017H	EKDB3G(T)A-403017H	400	300	170	109	360×260	360×315
EKDB3G(T)P-403017Z	EKDB3G(T)A-403017Z	400	300	170	109	360×260	415×260
EKDB3G(T)P-3030170	EKDB3G(T)A-3030170	300	300	170	109	260×260	315×260
EKDB3G(T)P-302017H	EKDB3G(T)A-302017H	300	200	170	109	260×160	260×215
EKDB3G(T)P-302017Z	EKDB3G(T)A-302017Z	300	200	170	109	260×160	315×160

L	outer height
W	outer width
Z	outer depth
C	available depth
B	bottom plate installation
A	base plate installation
E	wall installation
S	wall installation

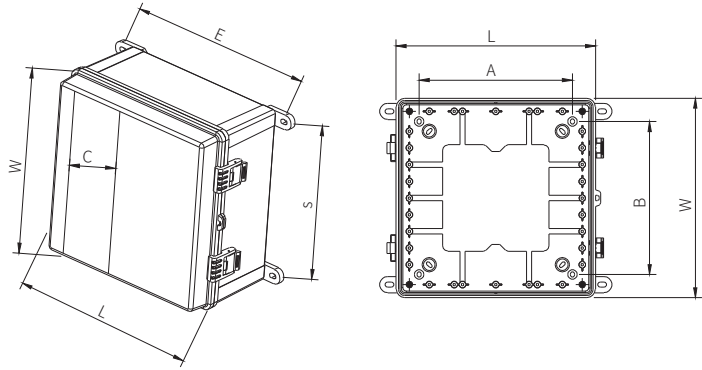

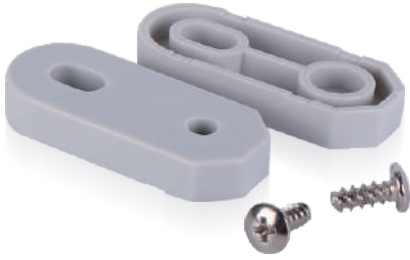

Applicable accessories

Name

Plastic box mounting feet

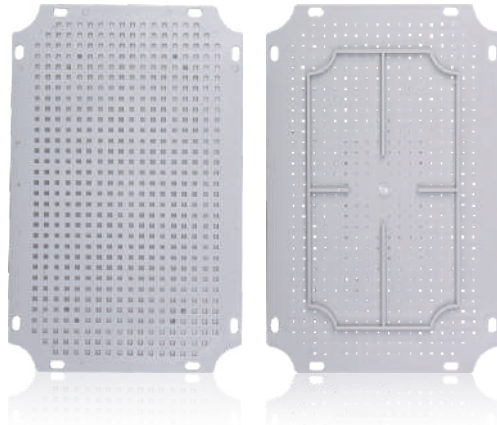

Name

Plastic box with plastic bottom plate suitable for 300×200×170

Plastic box with plastic bottom plate suitable for 300×300×170

Plastic box with plastic bottom plate suitable for 400×300×170

Plastic box with plastic bottom plate suitable for 500×400×200

Plastic box with plastic bottom plate suitable for 600×400×220

Plastic box with plastic bottom plate suitable for 600×500×220



Name

Galvanized plate bottom plate of plastic box is suitable for 300×200×170

Galvanized plate bottom plate of plastic box is suitable for 300×300×170

Galvanized plate bottom plate of plastic box is suitable for 400×300×170

Galvanized plate bottom plate of plastic box is suitable for 500×400×200

Galvanized plate bottom plate of plastic box is suitable for 600×400×220

Galvanized plate bottom plate of plastic box is suitable for 600×500×220



Applicable accessories

Name

Plastic box plastic inner door suitable for 300×200×170

Plastic box plastic inner door suitable for 300×300×170

Plastic box plastic inner door suitable for 400×300×170

Plastic box plastic inner door suitable for 500×400×200

Plastic box plastic inner door suitable for 600×400×220

Plastic box plastic inner door suitable for 600×500×220



Name

Plastic box galvanized plate inner door suitable for 300×200×170

Plastic box galvanized plate inner door suitable for 300×300×170

Plastic box galvanized plate inner door suitable for 400×300×170

Plastic box galvanized plate inner door suitable for 500×400×200

Plastic box galvanized plate inner door suitable for 600×400×220

Plastic box galvanized plate inner door suitable for 600×500×220



Description

The Distribution Box is used for Terminal power distributing system
 The Distribution Box are completed with Din-rail 35mm and Neutral Terminal (Selectable)

Electrical Rating	100A/single phase,63A/three phase,240/415V AC 50/60Hz
Protection Degree	IP65
Material	Shell: ABS
	Door: Transparent PC
Method of Installation	Surface-Mounted

Type of open door from right to left

Without Neutral Terminal Model

Model No.		Ways	Dimension(mm)			Qty/CTN
PC	Code		L	W	H	Pcs
EKDB4P4R	604241	4	231	166	113	30
EKDB4P6R	604242	6	231	202	113	20
EKDB4P8R	604243	8	231	238	118	20
EKDB4P9R	604244	9	219	200	102	20
EKDB4P12R	604245	12	246	310	148	20
EKDB4P18R	604246	18	286	418	148	20
EKDB4P24R	604247	24	436	310	148	10

With Neutral Terminal Model

Model No.		Ways	Dimension(mm)			Qty/CTN
PC	Code		L	W	H	Pcs
EKDB4P4RT	604211	4	231	166	113	30
EKDB4P6RT	604212	6	231	202	113	20
EKDB4P8RT	604213	8	231	238	118	20
EKDB4P9RT	604214	9	219	200	102	20
EKDB4P12RT	604215	12	246	310	148	20
EKDB4P18RT	604216	18	286	418	148	20
EKDB4P24RT	604217	24	436	310	148	10

Overall and Installation Dimension(mm)

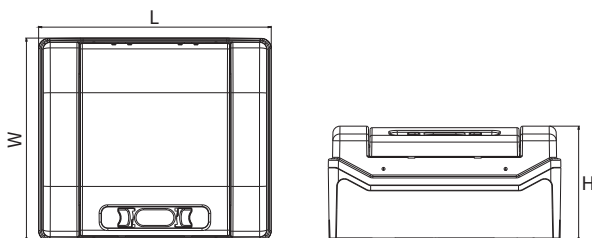



Description

In the photovoltaic industry, the proportion of EKDB5 combiner boxes used in photovoltaic equipment in developed countries in Europe and the United States has reached 53%, while the proportion in China is only 16%. And just two years ago this ratio was still less than 5%. Because combiner boxes are used in harsh environments such as outdoors, they have very high core requirements on the corrosion resistance, service life, impact resistance, weather resistance, and protection level of the components in the box. Compared with the metal box, the corrosion resistance of the EKDB5 box is twice that of the metal, and the service life is 2 to 3 times that of the metal. The impact resistance and weather resistance are both higher than the metal box, and the protection level is 22 times higher than that of the metal box. %, IPKIS has more innovatively customized silicone sealing strips, with a protection level of IP67, which is a must-select product for water photovoltaic projects. Therefore, at present, domestic photovoltaic manufacturers have begun to develop and use combiner boxes based on EKDB5 engineering plastics. It is believed that within a few years, they can keep up or exceed the proportion of metal boxes.

After several years of concentrated practice, with the courage to be the first in the world, after full market research, the first generation launched the unique 930×730×260 and 730×580×260 two specifications and four uses, and invested the whole process production equipment in the company. The production and processing has attracted the attention and praise of the industry; now the second generation 933×733×260 and 733×733×260 products have been launched soon, and the submarine trademark has been registered as a special brand for plastic protective sealed boxes to meet the increasing needs of customers.

Model meaning of FRP plastic sealed box

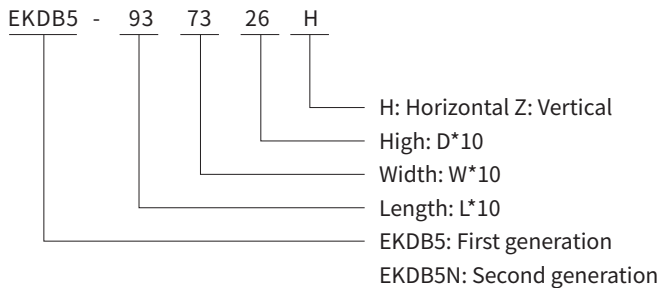

Main Technical Data

Model No.	Dimension(mm)					
	Length	width	height	Available depth	Base plate installation	Wall installation
(Material)EKDB5	L	W	D	C	B×A	E×S
EKDB5-937326H	930	730	260	230	816×620	816×701
EKDB5-937326Z	930	730	260	230	816×620	897×620
EKDB5-735826H	730	580	260	230	621×470	621×551
EKDB5-735826Z	730	580	260	230	621×470	702×470
EKDB5N-937326H	933	733	260	230	790×590	790×672
EKDB5N-737326	733	733	260	230	590×590	672×590

L	outer height
W	outer width
Z	outer depth
C	available depth
B	bottom plate installation
A	base plate installation
E	wall installation
S	wall installation

EKDB5

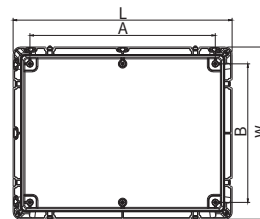
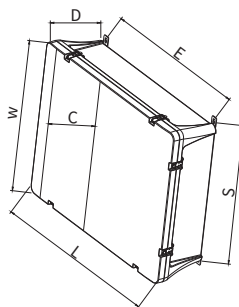

EKDB5N

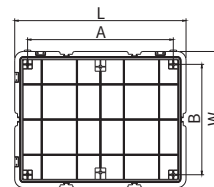
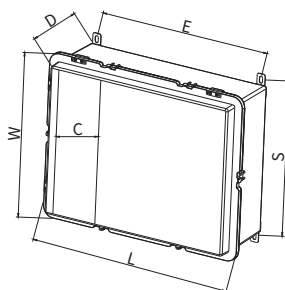

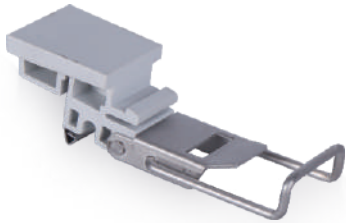

Applicable accessories

Name

EKDB5N box 304 stainless steel buckle



Name

EKDB5N box 304 stainless steel padlock

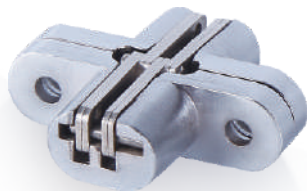

Name

EKDB5N box 304 stainless steel hinge



Name

EKDB5N box 737326 mounting base plate

EKDB5N box 937326 mounting base plate

Applicable accessories



Name

EKDB5 box 304 stainless steel buckle



Name

EKDB5 box 304 stainless steel hinge



Name

EKDB5 box 304 stainless steel padlock



Name

EKDB5 box 304 stainless steel mounting feet

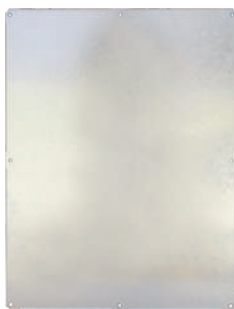

Name

EKDB5 box 735826 bottom plate

EKDB5 box 937326 bottom plate

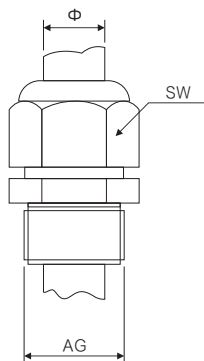

Technical Parameters

Material	UL approved nylon PA66, nitrile rubber
Thread Specifications	Metric, PG, G, NPT
Operating temperature	Static -40°C ~ 100°C, instantaneous heat to 120°C, dynamic -20°C ~ 80°C, instantaneous heat to 100°C
Features	Special clamping claws and rubber parts design, clamping range, especially tensile strength, waterproof, dustproof, salt, acid, alcohol, grease and common solvents
Color Category	Black, gray, special colors (white, red, blue, dark gray) can be customized
Protection class	IP68

Specifications Model

Model	Thread size (mm)	Hole size AG(mm)	Thread length (mm)	Wall thickness (mm)	Applicable cable Φ(mm)	Wrench size SW(mm)
PG7	12.5	Φ12.6-13	9	3	3.5-7	18/16
PG9	15.2	Φ15.3-15.5	9	3	4-9	22/19
PG11	18.6	Φ18.7-19	9	3	5-11	24/22
PG13.5	20.4	Φ20.5-21	9	4	6-12	27/24
PG16	22.5	Φ22.6-23	10	5	10-14	30/27
PG19	24	Φ24.2-24.5	10	5	12-15	30/28
PG21	28.3	Φ28.5-29	12	5	13-18	36/33
PG25	30	Φ30.2-30.5	12	6	16-21	37/35
PG29	37	Φ37.2-37.5	12	6	18-25	45/42
PG36	47	Φ47.3-48	17	7	22-32	58/52
PG42	54	Φ54.5-55	19	7	32-39	65/60
PG48	59.3	Φ60-61	19	7	37-44	70/69
PG63	71	Φ71.5-72	27	19	42-51	83/75

Series Waterproof Connector

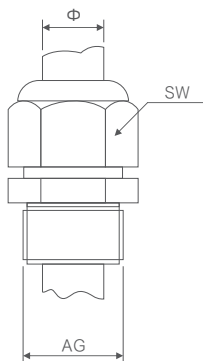

Technical Parameters

Material	UL approved nylon PA66, nitrile rubber
Thread Specifications	Metric, PG, G, NPT
Operating temperature	Static -40°C ~ 100°C, instantaneous heat to 120°C, dynamic -20°C ~ 80°C, instantaneous heat to 100°C
Features	Special clamping claws and rubber parts design, clamping range, especially tensile strength, waterproof, dustproof, salt, acid, alcohol, grease and common solvents
Color Category	Black, gray, special colors (white, red, blue, dark gray) can be customized
Protection class	IP68

Specifications Model

Model	Thread size (mm)	Hole size AG(mm)	Thread length (mm)	Wall thickness (mm)	Applicable cable Φ(mm)	Wrench size SW(mm)
M12	M12×1.5	Φ12.2-12.5	9	3	3-7	18/16
M16	M16×1.5	Φ16.2-16.5	9	3	4-8	22/19
M18	M18×1.5	Φ18.2-18.5	9	3	5-10	24/22
M20	M20×1.5	Φ20.2-20.5	9	5	6-12	27/24
M22	M22×1.5	Φ22.2-22.5	10	5	10-14	30/27
M24	M24×1.5	Φ24.2-24.5	10	5	12-15	33/28
M25	M25×1.5	Φ25.2-25.5	10	5	13-15	33/28
M25	M25×1.5	Φ25.2-25.5	12	5	13-18	33/30
M27	M27×1.5	Φ27.2-27.5	12	5	13-18	35/33
M30	M30×1.5	Φ30.2-30.5	12	6	16-21	37/37
M32	M32×1.5	Φ32.2-32.5	12	6	16-21	39/35
M36	M36×1.5	Φ36.2-37	12	6	18-25	45/42
M40	M40×1.5	Φ40.2-41	17	7	20-26	52/52
M50	M50×1.5	Φ50.5-51	19	10	32-39	60/60
M63	M63×1.5	Φ63.5-64	19	10	37-44	74/69
M72	M72×1.5	Φ72.5-73	27	15	42-52	83/77

PV-LTM4(1000V)/PV-LTM4-1(1000V)

Solar DC Connector

Standard_ IEC60068-2-52



Technical Data

Connector system	Φ2.5mm~6mm
Rated voltage	1000V DC(IEC) ¹
Rated current	17A(1.5mm ²) 22A(2.5mm ² ; 14AWG) 30A(4mm ² ; 6mm ² ; 12AWG, 10AWG)
Test voltage	6kV(50HZ,1min.)
Ambient temperature range	-40°C... +90°C(IEC) -40°C... +75°C(UL)
Upper limiting temperature	+105°C(IEC)
Degree of protection, mated	IP67
unmated	IP2X
Contact resistance of plug connectors	0.5mΩ
Safety class	II
Contact material	Messing, verzinkt Copper Alloy, tin plated
Insulation material	PC/PPO
Locking system	Snap-in
Flame class	UL-94-V0
Salt mist spray test, degree of severity 5	IEC 60068-2-52

Overall and Installation Dimension(mm)

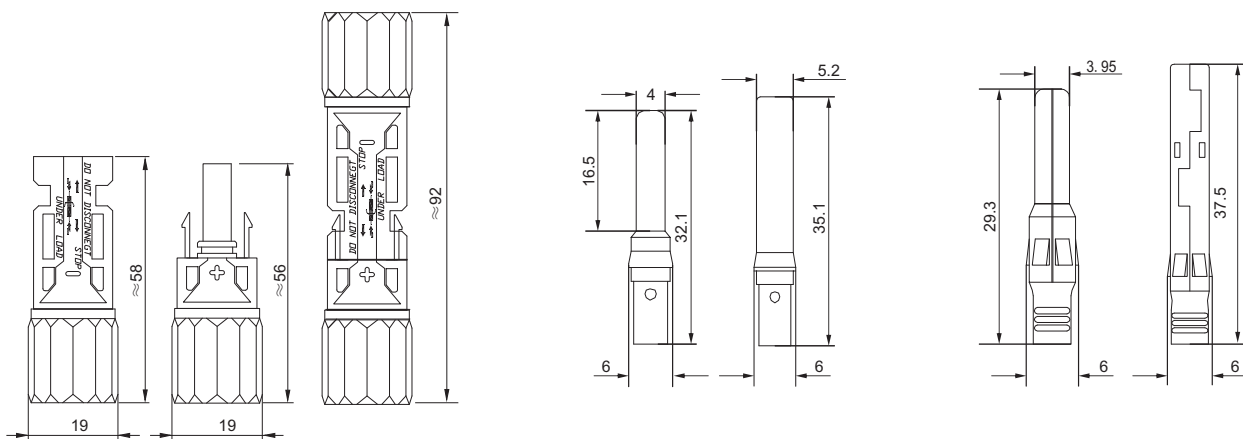

PV-LTM01(1000V)/PV-LTM01-1(1000V)



Solar DC Connector

Standard_ IEC60068-2-52



Technical Data

Connector system	Φ2.5mm~6mm
Rated voltage	1000V DC(IEC) ¹
Rated current	17A(1.5mm ²) 22A(2.5mm ² ; 14AWG) 30A(4mm ² ; 6mm ² ; 12AWG, 10AWG)
Test voltage	6kV(50HZ,1min.)
Ambient temperature range	-40°C... +90°C(IEC) -40°C... +75°C(UL)
Upper limiting temperature	+105°C(IEC)
Degree of protection, mated	IP67
unmated	IP2X
Contact resistance of plug connectors	0.5mΩ
Safety class	II
Contact material	Messing, verzinkt Copper Alloy, tin plated
Insulation material	PC/PPO
Locking system	Snap-in
Flame class	UL-94-V0
Salt mist spray test, degree of severity 5	IEC 60068-2-52

Overall and Installation Dimension(mm)

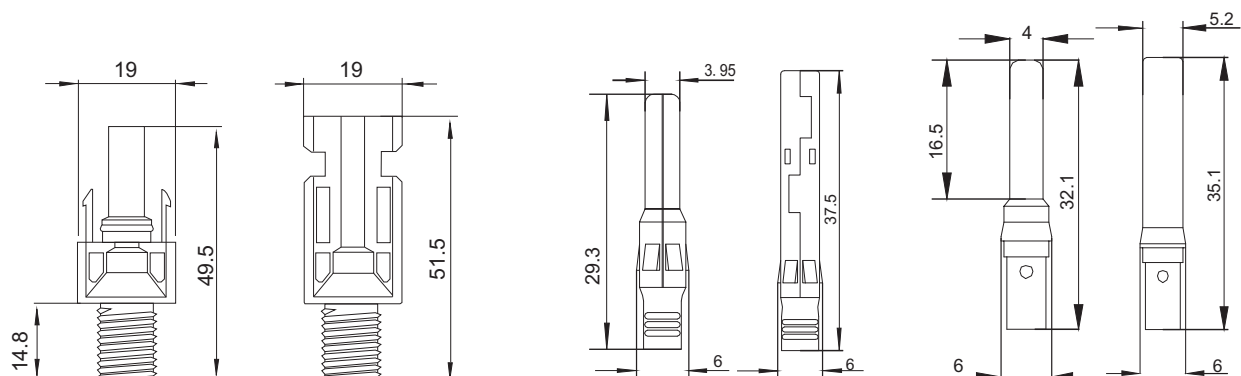

▼ CERTIFICATE ▲

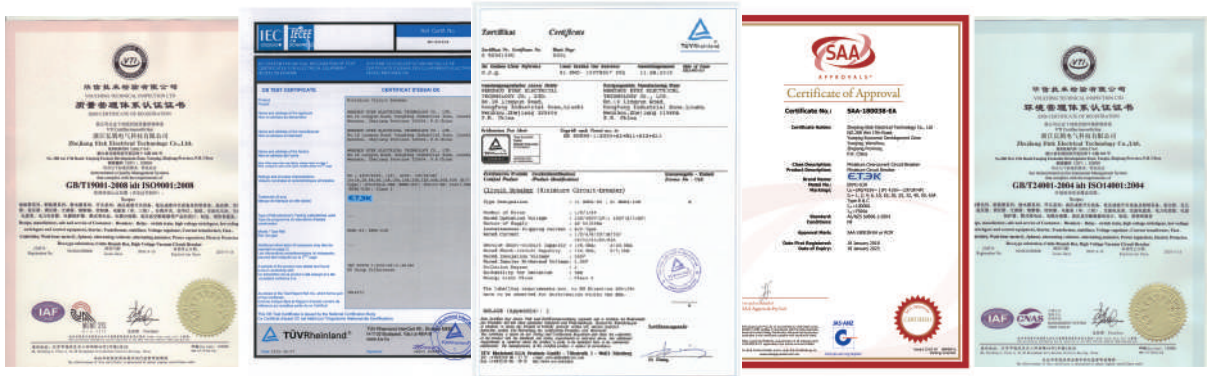

▼ PACKAGING ▲



Old Packaging



New Packaging

▼ SHIPPING ▲



Tel-
0086-577-62718777

Fax-
0086-577-62774090

Email-
sales@etek-china.com

No. 288 Wei 17th Road,
Economic Development Zone,
Yueqing City Zhejiang China.

ETEK[®]
E TEK ELECTRIC

ZHEJIANG ETEK
ELECTRICAL TECHNOLOGY CO.,LTD.

